

Assembly Instructions confocalDT 2421

Functions

- Distance measurement against reflecting (mirroring and diffuse) surfaces
- Thickness measurement of transparent objects
- Triggering, synchronization and further functions
- Ethernet- or EtherCAT interface
- Measuring rate up to 6.5 kHz

Warnings

Connect the power supply in accordance to the safety regulations for electrical equipment. The power supply may not exceed the specified limits.

> Danger of injury, damage to or destruction of the system

Protect the optical fiber ends from dirt and contamination, protect the cables from damage.

> Failure of the measurement device

Avoid shock and vibration to the controller or the sensor.

> Damage to or destruction of the system

Notes on CE Identification

The following applies to the confocalDT 2421: EU directive 2014/30/EC

EU directive 2011/65/EC, "RoHS" category 9

The system satisfies the requirements of the standards

- EN 61000-6-3 / EN 61326-1 (Class B) Interference emission
- EN 61000-6-2 / EN 61326-1 Immunity to interference

Proper Environment

- Protection class IP 40 (Controller)
IP 40 - IP 64 (Sensor)
- Operating temperature
Controller: 5 ... +50 °C (+41 ... +122 °F)
Sensor: 5 ... +70 °C (+41 ... +158 °F)
- Storage temperature: -20 ... +70 °C (-4 ... +158 °F)

For further informations about the system read the instruction manual. You will find this online at: www.micro-epsilon.com/download/manuals/man--confocalDT-2421-2422--en.pdf or on the delivered CD.

Assembly

Place the controller IFC2421 on a level surface, or install it at a location of your choice (e.g. in a switch cabinet) using a DIN EN 60715 mounting rail (DIN rail TS35).

▶ To remove, push the controller upwards, and pull it forwards.

- When attaching the controller, ensure that no connections, operating or display elements are covered.

Dimensional Drawing IFC2421

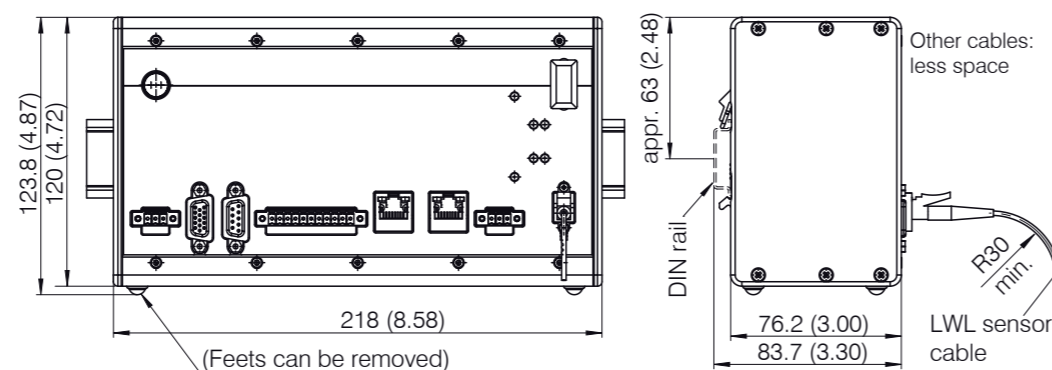

Sensor Cable, Optic Fiber

Do not shorten or lengthen the optical fibers. A damaged sensor cable cannot be repaired, but replaced only.

- Avoid any contamination of the connector, mechanical stress, bending the cable.
Minimum bending radius: 30 mm fixed, 40 mm permanent flexible

Mounting Sensor, Installation Bracket

The optical sensors of series IFS240x measure with micrometer accuracy.

- Please ensure careful handling during installation and operation!

▶ Use an installation bracket or use the mounting area resp. mounting thread to mount IFS 240x sensors.

Sensor	IFS2402-x	IFS2403-x	IFS2405-0,3	IFS2405-1	IFS2406-3	IFS2406-10	IFS 2405-3	IFS 2405-10	IFS2405-28	IFS2405-30	IFS2406-2,5	IFS2407/90-0,3
Adapter												
MA2402-4	•											
MA2403		•										
MA2400-27			•									
MA2405-34							•					
MA2405-54								•				
MA2405-62									•			
MA2406-20										•		
Mounting thread												•

MICRO-EPSILON MESSTECHNIK
 GmbH & Co. KG
 Königbacher Str. 15 · 94496 Ortenburg
 www.micro-epsilon.com



X9771367.01-A031068MSC

Ethernet, EtherCAT

Potential isolated RJ 45 standard connectors for connecting the controller IFC2421 to an Ethernet network (PC) or the EtherCAT bus system (in/out).

The controller is connected with a PC or generally with a network via the Ethernet interface. The internal websites can be accessed in the controller with a web browser and so the controller can be operated.

Encoder Inputs

Two encoders can be connected simultaneously and powered with 5 V using the 15-pin HD-sub connector.

Each encoder provides A, B and N signals (zero pulse, reference, index).

The maximum pulse frequency is 1MHz. Values for A, B, N: RS422 level; reference value: GND

Encoder supply 5 V: 5 V each, max. 300 mA

Encoder	Pin	Signal	Encoder	Pin	Signal
1	1	GND ENC1	2	11	GND ENC2
	5	A1+		3	A2+
	4	A1-		2	A2-
	10	N1+		8	N2+
	9	N1-		7	N2-
	15	B1+		13	B2+
14	B1-	12	B2-		
6	ENC U _p +5V	6	ENC U _p +5V		

Connector housing Controller housing Cable screen

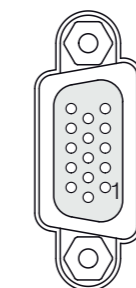

View on solder pin side male cable connector

Connect the cable shields to the connector housings and the encoder housings.

Analog Output

The analog output can either be used for distance or thickness measurements. Only one type of measurement can be transmitted at any given time.

The analog output has a resolution of 16 bit. Either the voltage or the current output on the controller can be used at any given time.

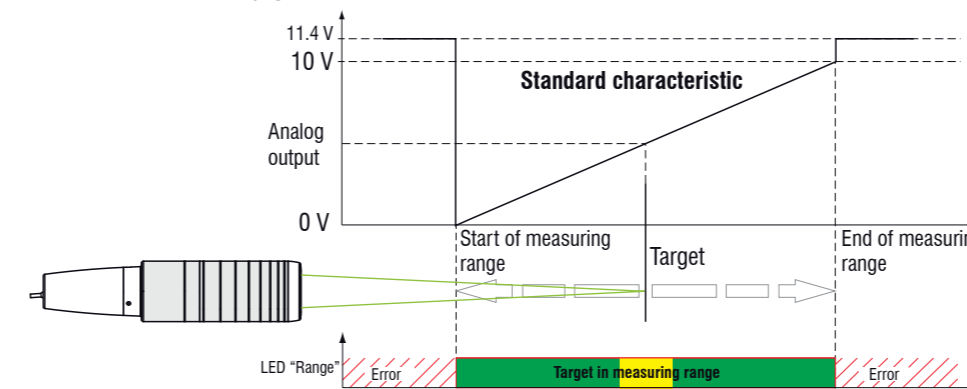

Screw Terminals

Pin	Description	Comments
U/I out	Voltage output	0 ... 5 V; 0 ... 10 V; R _i 50 Ohm;
	Current output	4 ... 20 mA; R _L ≤ 500 Ohm
GND	Ground analog output	Galvanically connected with supply

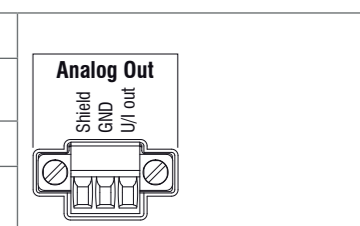

+ Sync/Trig - Sync/Trig	Input/output synchronization, input triggering	RS422 level (EIA422)
TrigIn	Input triggering	TTL or HTL level TTL: Low ≤ 0.8 V, High ≥ 2 V HTL: Low ≤ 3 V, High ≥ 8 V
Error 1 / 2	Error outputs	NPN, PNP or Push-Pull, I _{max} = 100 mA, U _{H max} = 30 V
GND	Ground potentials	All GND are connected to each other and to the operating voltage ground.

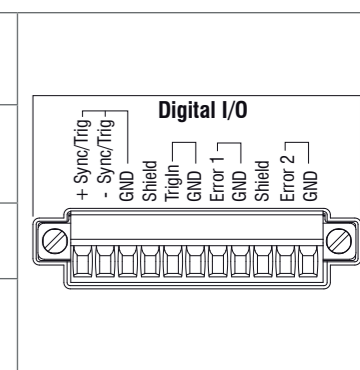

24 VDC	Operating voltage	± 15 %, I _{max} < 1 A
GND	Operating voltage ground	GND is galvanically connected to GND of switching outputs, synchronization, analog and encoder input.
Shield	Shields to respective output/input, connector housing	

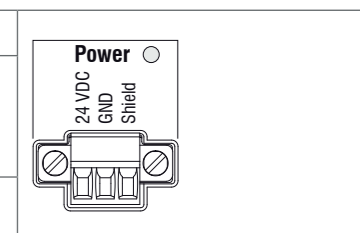

The plug-in screw terminals are designed for a conductor cross-section of 0.14 mm² up to 1.5 mm². The screw terminals are mounted with two screws on the controller and can be removed for the wiring or a quick controller change.

LEDs

Power	Green	Supply voltage ok
Status	Off	No error
	Red flashing	Processing error
If the EtherCAT interface is active, then the meaning of the Status-LED is conform with the EtherCAT guidelines.		
Intensity	Red flashing	Dark signal acquisition in progress
	Red	Signal in saturation
	Yellow	Signal too low
Sensor 1	Green	Signal ok
	Red flashing	Dark signal acquisition in progress
	Red	No target or out of range
Range	Yellow	Target in midrange
	Green	Target in the measuring range
	Green	Target in the measuring range

The LED's Intensity and Range flashes with their current color during a synchronization error.

Quick Guide

Structure of the Components

- Controller
- Power supply
- Laptop / PC + USB -> Ethernet adapter + Ethernet cable
- Sensor and clamp

➔ Connect the components together and mount the sensor into the clamp.

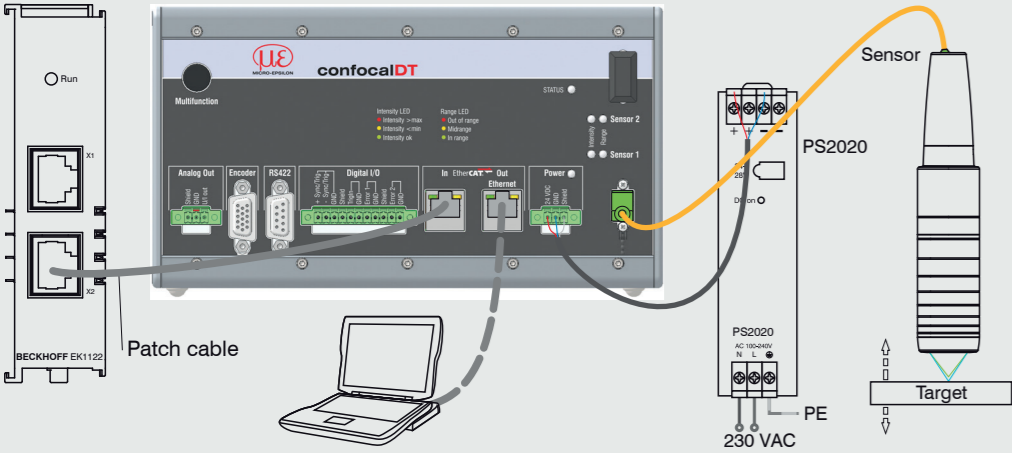

Commissioning

The controller is delivered ex factory with the IP address 169.254.168.150.

You can check the IP address of the controller, that are connected to a PC / network, with the SensorFinder.exe program. You will find this program on the provided CD.

➔ Now start the SensorFinder.exe and click on the button Start Scan.

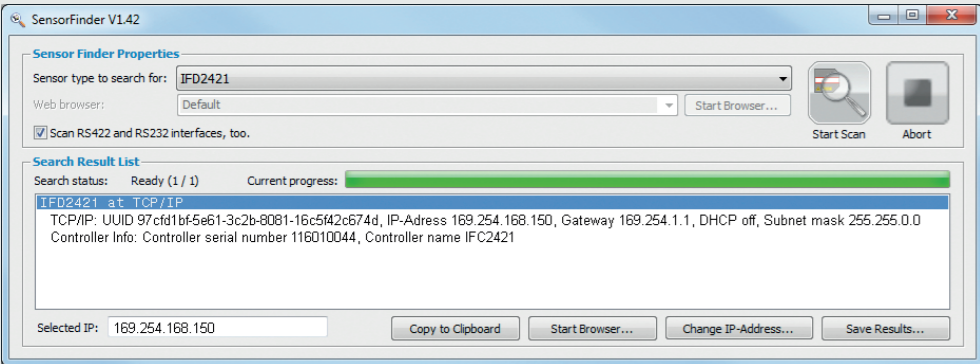

➔ Select the designated controller from the list.

➔ Click the button Start Browser to connect the controller with your default browser.

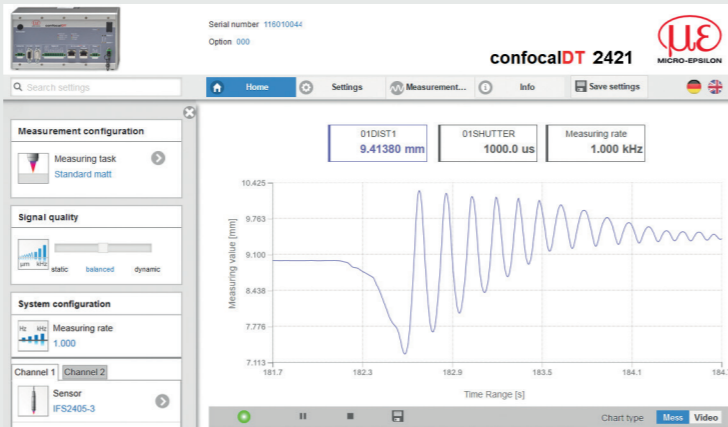

The start screen of the controller software should be displayed in the web browser now.

Select Sensor

- ➔ Go to the menu Settings > Sensor.
- ➔ Select a sensor from the list.

Perform Dark Reference

This adjustment is necessary after each sensor change; warm-up time controller about 30 min.

- ➔ Cover the sensor with a piece of dark paper. Go to the menu Settings > Sensor > Dark reference and press the Start button.

For dark referencing, no object must be within the measuring range, and no external light must reach the sensor. Duration about 20 s.

Place Target

- ➔ Place the target in the midrange.

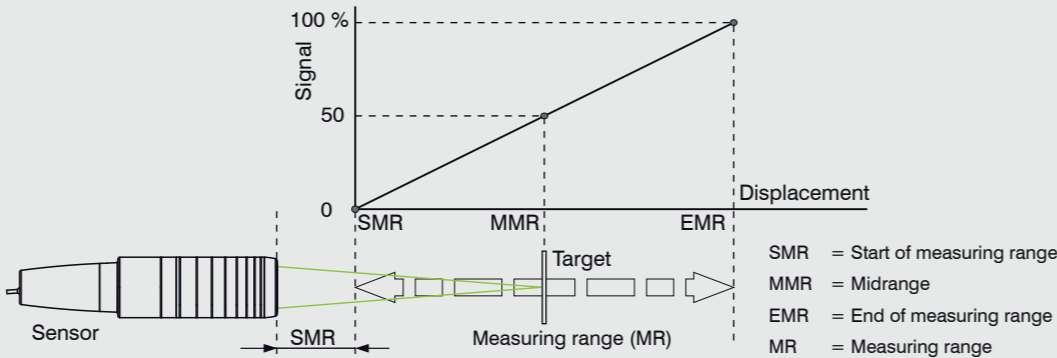

The LED Range on the front side of the controller shows the position of the target to the sensor.

Red flashing	Dark signal acquisition in progress
Red	No target, or target outside the measuring range
Yellow	Target near the midrange
Green	Target within the measuring range

Measurement Configuration

- ➔ Go to the Home > Measurement configuration menu and start the configuration selection. Select a stored configuration (preset). In a preset the basic features like peak, material or billing functions are already set.

- Standard matt**: Distance measurement e.g. on ceramics, non-transparent plastics. Highest peak, no averaging, distance calculation.
- Standard shiny**: Distance measurement e.g. on metals, polished surfaces. Highest peak, median over 5 values, distance calculation.
- Multisurface**: Distance measurement e.g. on PCB, hybrid materials. Highest peak, median over 9 values, distance calculation.
- One-sided thickness measur...**: Thickness measurement e.g. of glass, BK7 materials. First and second peak, no averaging, thickness calculation.
- Multilayer air gap**: Thickness measurement¹ e.g. of mask under glass. 1. layer BK7, 2. layer air, first and second peak, median over 5 values.
- Multilayer laminated glass**: Layer thickness measurement¹ of laminated glass e.g. windshield, 1. layer BK7, 2. layer PC, 3. layer BK7, first and second peak, no averaging.

Individual material selection is possible in Settings > Data recording > material selection.
1) Programs available in controller with multi-peak functionality.

Check Video Signal

- ➔ Go to the Measurement chart menu. Activate the video signal display with Video. If necessary, adjust the settings for the exposure mode and the measuring rate.

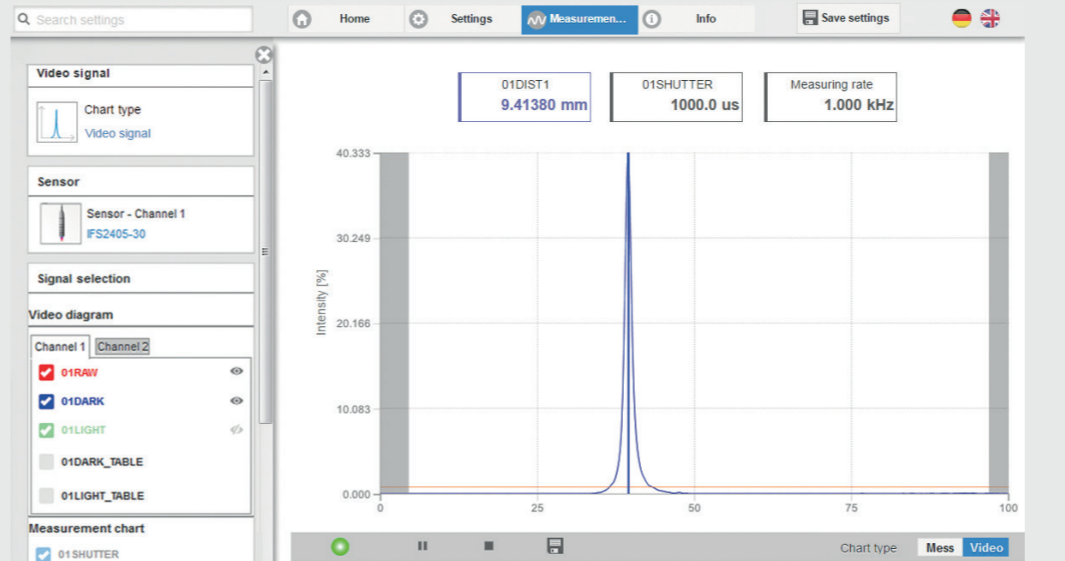

Signal quality

A good measurement result can be achieved with sufficient video signal intensity. Reducing the measuring rate enables longer exposure of the CCD array, therefore leading to high measurement quality.

- ➔ Go to the menu Home > Signal quality and adapt the measurement dynamics to the requirements. Check the result in the video signal.

Signal quality	Measuring rate	Averaging
static	200 Hz	Moving, 128 values
balanced	1 kHz	Moving, 16 values
dynamic	6.5 kHz	Moving, 4 values

Menu Measurement

- ➔ Switch to the menu Measurement chart > Signal selection. Click on the checkboxes in the section Measurement graph in order to display the corresponding signals. Confirm settings by clicking on Save settings.

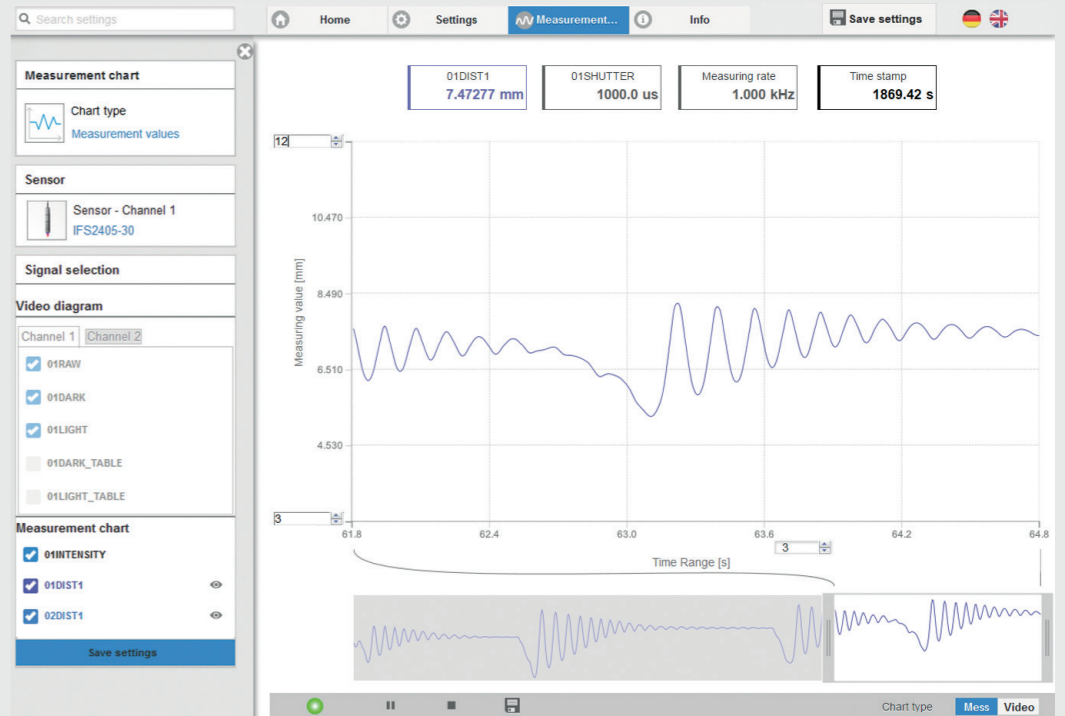

Save Settings

Not saved settings are lost when switching off. Save your settings in setups.

- ➔ Create a setup (Settings > System settings > Load & Save menu) and click on the Save button.