

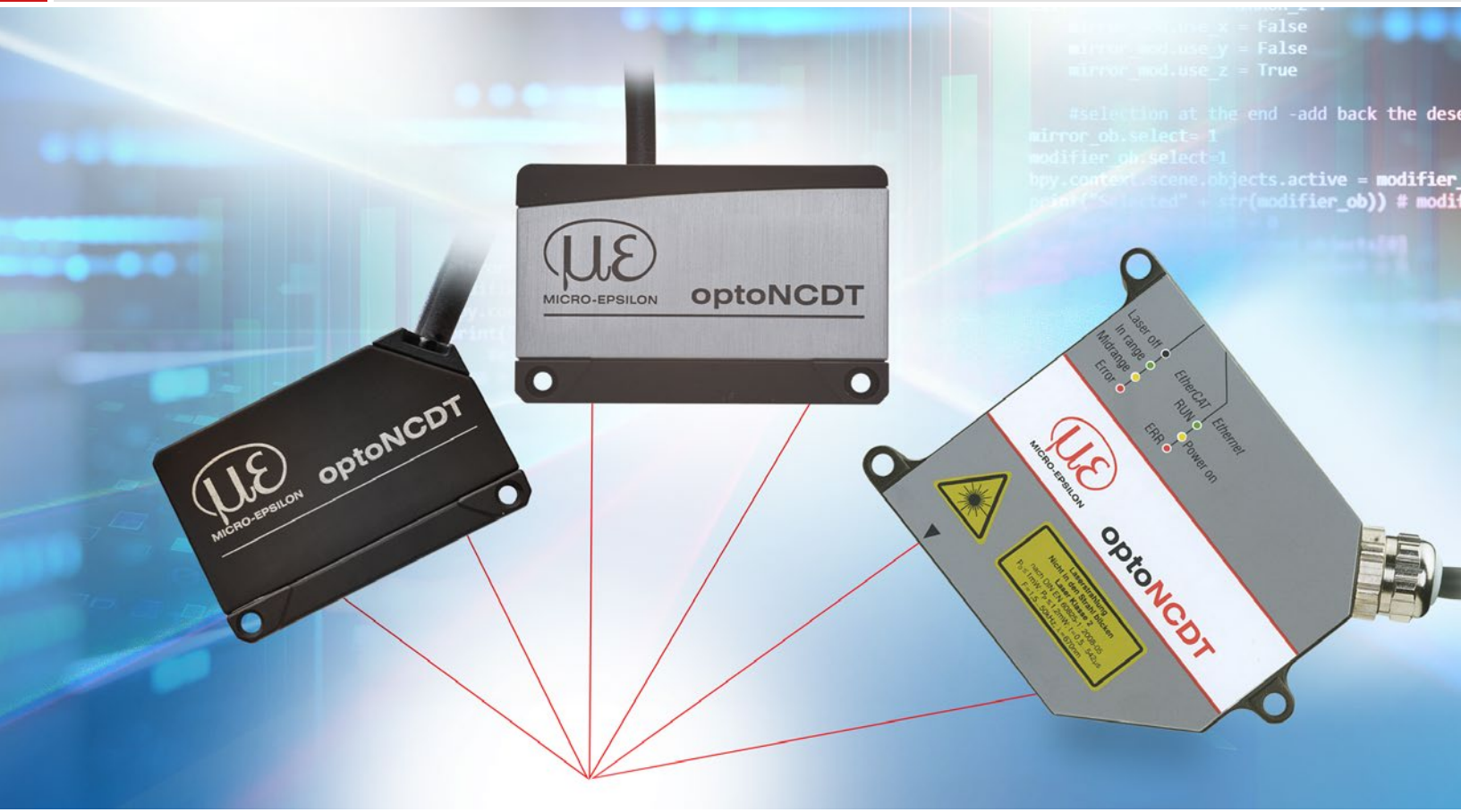

More Precision

optoNCDT // Laser displacement sensors (triangulation)



optoNCDT 23x0

High precision laser sensors

from page 34



Model	Technology	Measuring range	Repeatability	Linearity
optoNCDT 2300		2 - 300 mm	0.03 μm	from 0.02 %
optoNCDT 2300BL		2 - 50 mm	0.03 μm	from 0.02 %
optoNCDT 2300LL		2 - 50 mm	0.1 μm	from 0.02 %
optoNCDT 2300-2DR		2 mm	0.03 μm	from 0.03 %
optoNCDT 2310		10 - 50 mm	0.5 μm	from 0.03 %

optoNCDT 17x0

Laser sensors for special measurement tasks

optoNCDT 1910





from page 46



Model	Technology	Measuring range	Repeatability	Linearity
optoNCDT 1750BL		2 - 750 mm	0.8 μm	from 0.06 %
optoNCDT 1750-DR		2 - 20 mm	0.1 μm	0.08 %
optoNCDT 1710		50 mm	from 7.5 μm	0.10 %
optoNCDT 1710BL		50 / 1000 mm	7.5 μm	from 0.10 %
optoNCDT 1760		1000 mm	from 7.5 μm	0.10 %
optoNCDT 1910		500 / 750 mm	from 20 μm	0.07 %

Powerful laser sensors for special applications

optoNCDT 17x0 / optoNCDT 1910

-  Adjustable measuring rate up to 10 kHz
-  Analog (U/I) / RS422 / PROFINET / EtherNet/IP
-  Fast surface compensation
-  High repeatability
-  Ideal for large measurement distances

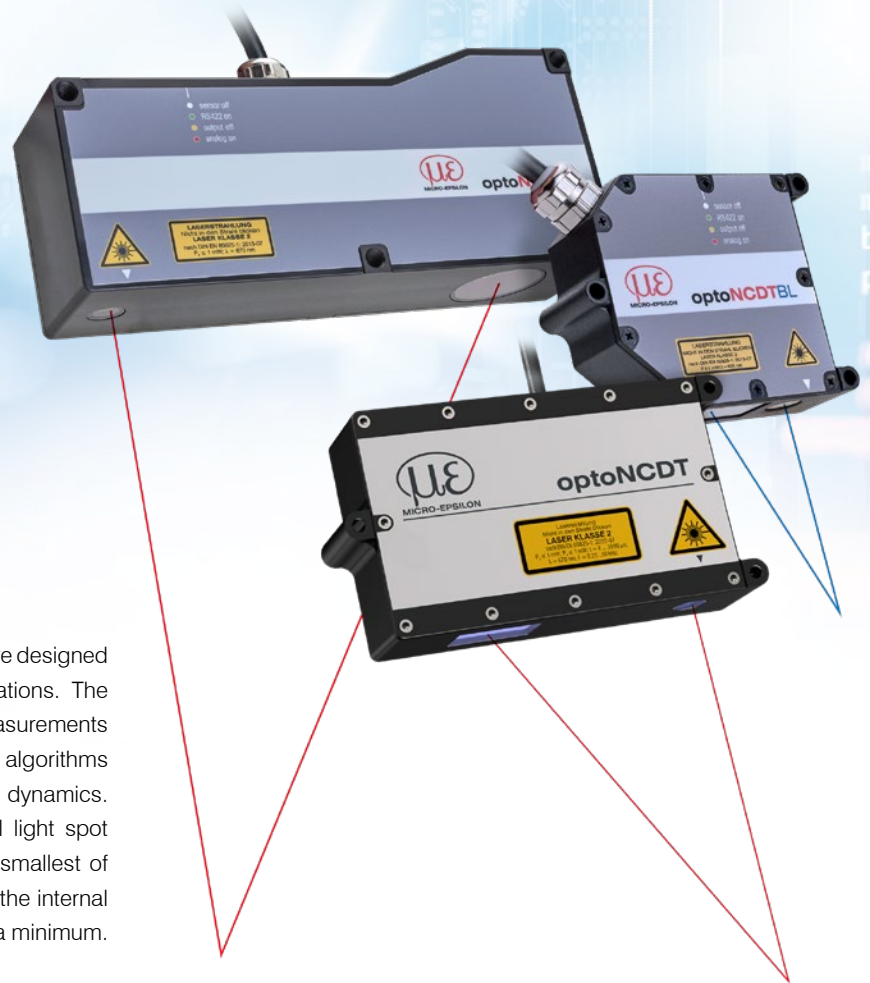







The optoNCDT 1910, 1710 and 1750 series laser sensors are designed for fast and precise measurements in industrial applications. The models are used for demanding surfaces and impress in measurements where large distances are required. Innovative evaluation algorithms and improved components enable high accuracy and dynamics. The high-performance optical system generates a small light spot onto the target which enables the detection of even the smallest of components reliably. The pigtail cable in conjunction with the internal controller reduces the installation effort for the sensors to a minimum.

The intelligent exposure control for demanding surfaces

The optoNCDT 1750 sensors feature real-time surface compensation. The real-time surface compensation feature (RTSC) determines the amount of reflection from the target surface during continuous exposure and in real-time. The exposure time or the amount of light produced by the laser is optimally matched to the reflection characteristics of the target surface. This enables extremely reliable measurements even on reflecting surfaces. The optoNCDT 1910 sensors use Advanced Surface Compensation and are also highly resistant to ambient light.

Ideal for industrial applications

Different output signals enable the integration of the sensor into plant and machine control systems. As well as analog voltage and current outputs, a digital interface provides distance information from the sensor. Due to the universal setting and evaluation possibilities, the sensors meet all the requirements for use in industrial applications.

Model	Technology	Measuring range	Repeatability	Linearity
optoNCDT 1750BL		2 - 750 mm	0.8 μm	from 0.06 %
optoNCDT 1750-DR		2 - 20 mm	0.1 μm	0.08 %
optoNCDT 1710		50 mm	from 7.5 μm	0.10 %
optoNCDT 1710BL		50 / 1000 mm	7.5 μm	from 0.10 %
optoNCDT 1760		1000 mm	from 7.5 μm	0.10 %
optoNCDT 1910		500 / 750 mm	from 20 μm	0.07 %

Large distance and large measuring range

The optoNCDT long-range models are used to cover a large measuring range or to measure from a large distance to the target. The long-range laser sensors combine high accuracy and large measuring distances.

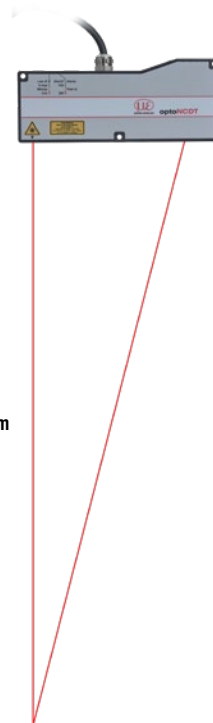

Measurement distances up to 2 m

Application examples



Geometry testing of reflective glass parts

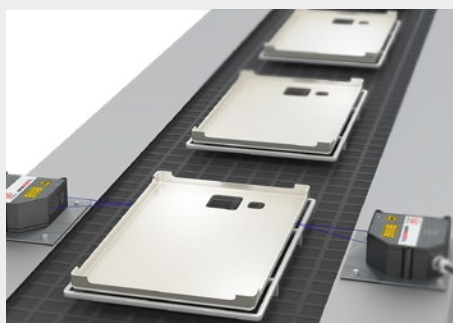

Position check of plastic components

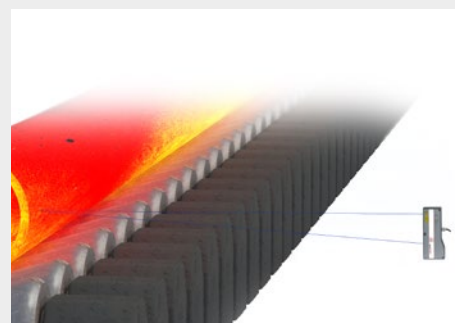

Position measurement of red-hot glowing pipes

Technical data

optoNCDT 17x0 Laser sensors for large measuring ranges



Long-Range - optoNCDT 1760

Model		ILD1760-1000
Measuring range		1 000 mm
Start of measuring range		1 000 mm
Mid of measuring range		1 500 mm
End of measuring range		2 000 mm
Measuring rate ^[1]		6 adjustable stages: 7.5 kHz / 5 kHz / 2.5 kHz / 1.25 kHz / 625 Hz / 300 Hz
Linearity ^[2]		< ±1000 μm < ±0.1 % FSO
Repeatability ^[3]		100 μm
Light spot diameter ^[4]	SMR	2500 ... 5000 μm
	MMR	
	EMR	
Light source		Semiconductor laser < 1 mW, 670 nm (red)
Laser class		Class 2 in accordance with DIN EN 60825-1: 2022-07
Permissible ambient light		10,000 lx
Supply voltage		11 ... 30 VDC
Max. current consumption		150 mA (24 V)
Signal input		1 x HTL/TTL laser on/off; 1 x HTL/TTL multi-function input: trigger in, slave in, zero setting, mastering, teach-in; 1 x RS422 synchronization input: trigger in, sync in, master/slave, master/slave alternating
Digital interface ^[5]		RS422 (16 bit) / EtherCAT / PROFINET / EtherNet/IP
Analog output		4 ... 20 mA / 0 ... 5 V / 0 ... 10 V (16 bit, freely scalable within the measuring range)
Switching output		2x switching outputs (error & limit value): npn, pnp, push pull
Connection		integrated pigtail 0.25 m with 14-pin ODU connector, min. bending radius 30 mm when firmly installed; optional extension to 3 m / 10 m possible (see accessories for suitable connection cables)
Installation		Screw connection via three mounting holes
Temperature range	Storage	-20 ... +70 °C (non-condensing)
	Operation	0 ... +50 °C (non-condensing)
Shock (DIN EN 60068-2-27)		15 g / 6 ms in 3 axes
Vibration (DIN EN 60068-2-6)		2 g / 20 ... 500 Hz
Protection class (DIN EN 60529)		IP65
Material		Aluminum housing
Weight		approx. 800 g (incl. pigtail)
Control and indicator elements ^[6]		Select & function keys: interface selections, mastering (zero), teach, presets, quality slider, frequency selection, factory settings; web interface for setup: application-specific presets, peak selection, video signal, freely selectable averaging possibilities, data reduction, setup management 2 x color LEDs for power / status

^[1] Factory setting 5 kHz, modifying the factory setting requires the IF2001/USB converter (see accessories)

^[2] FSO = Full Scale Output; the specified data apply to white, diffuse reflecting surfaces (Micro-Epsilon reference ceramic for ILD sensors)

^[3] Measuring rate 5 kHz, median 9

^[4] ±10 %; SMR = Start of measuring range; MMR = Mid of measuring range; EMR = End of measuring range

^[5] EtherCAT, PROFINET and EtherNet/IP require connection via interface module (see accessories)

^[6] Access to web interface requires connection to PC via IF2001/USB (see accessories)

Dimensions optoNCDT 17x0

optoNCDT 1710-50 / 1760-1000

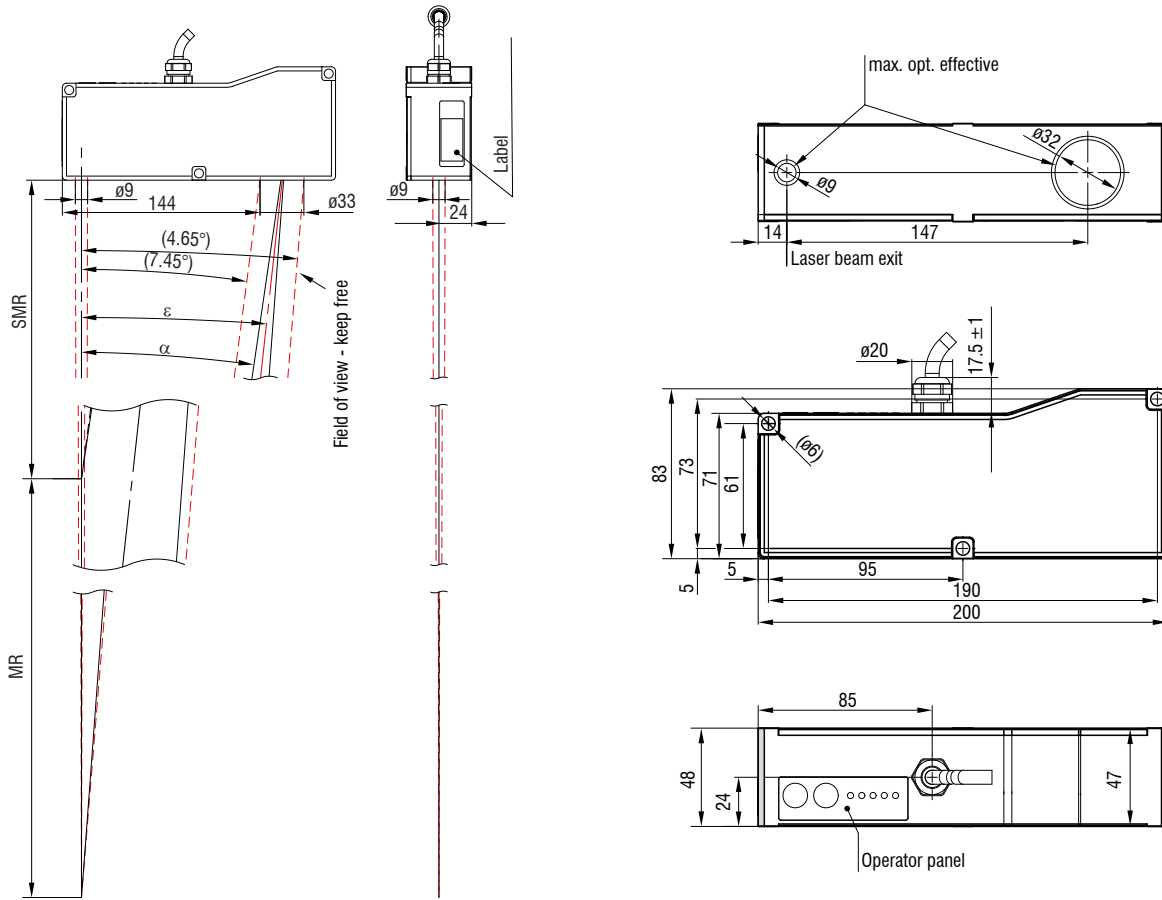

MR	SMR	α	ε
50	550	13.35 °	15.15 °
1000	1000	7.45 °	4.65 °

Connector (sensor side)

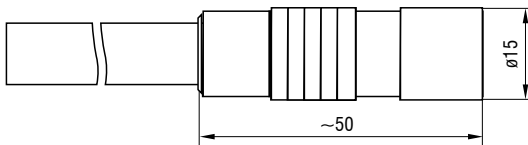

(Dimensions in mm, not to scale)

MR = measuring range; SMR = start of measuring range,

MMR = Mid of measuring range, EMR = end of measuring range





Connection possibilities

optoNCDT 17x0 / 1910

optoNCDT 1700 / 1750 / 1760



Drag-chain suitable extension and adapter cables

Cable diameter: 6.8 ±0.2 mm
 Drag chain: yes
 Robot: no
 Temperature range: -40 ... 90 °C (moving /not moving)
 Bending radius: > 55 mm (fixed installation / dynamic / drag chain)

Sensor	Cables	Type	Connection possibilities and accessories
ILD1710-50 ILD1710-xxBL	Extension cable pigtail Length 3 m / 6 m / 9 m / 15 m Art. no. Designation 2901189 PC1700-3 2901357 PC1700-6 2901191 PC1700-10 2901266 PC1700-15	Open ends	Supply voltage connection Power supply unit PS2020 
	ILD1750-xxBL ILD1750-xxDR ILD1760-1000		Sub-D
Interface module for Industrial Ethernet connection IF2035-PROFINET IF2035-EIP IF2035-EtherCAT (not for ILD1710) 			
Interface card for synchronous data acquisition IF2008PCIe / IF2008E 			
	Adapter cable for PC interface card Length 3 m / 6 m Art. no. Designation 2901555 PC1700-3/IF2008 2901556 PC1700-6/IF2008 2901557 PC1700-8/IF2008		4-fold USB converter IF2004/USB 
	Adapter cable for sensor calculation Length 3 m / 6 m / 9 m Art. no. Designation 29011173 PC1750-3/C-Box 29011180 PC1750-6/C-Box 29011181 PC1750-9/C-Box	Sub-D	Controller for D/A conversion and evaluation of up to 2 sensor signals Dual Processing Unit 



Robot-suitable extension cables

Cable diameter: max. 9 mm
 Drag chain: no
 Robot: yes
 Temperature range: -40 ... 70 °C (moving / not moving)
 Bending radius: 110 mm (dynamic)

Sensor	Cables	Type	Connection possibilities and accessories
ILD1710-50 ILD1710-xxBL	Extension cable pigtail: Length 3 m / 6 m / 9 m / 15 m Art. no. Designation 2901494 PCR1700-5 2901299 PCR1700-10	Open ends	Connection supply voltage PS2020 
	ILD1750-xxBL ILD1750-xxDR ILD1760-1000		Open ends
Interface module for Industrial Ethernet connection IF2035-PROFINET IF2035-EIP IF2035-EtherCAT (not for ILD1710) 			



Extension cables for high temperatures

Cable diameter:	max. 7.5 mm
Drag chain:	no
Robot:	no
Temperature range:	-55 ... 250 °C (moving) -90 ... 250 °C (not moving)
Bending radius:	> 40 mm (fixed installation) > 75 mm (dynamic)

Sensor	Cables	Type	Connection possibilities and accessories									
ILD1710-50 ILD1710-xxBL	Extension cables high temperatures Length 3 m / 6 m / 9 m / 15 m <table> <tr> <td><i>Art. no.</i></td> <td><i>Designation</i></td> </tr> <tr> <td>29011091</td> <td>PC1700-3/OE/HT</td> </tr> <tr> <td>29011092</td> <td>PC1700-6/OE/HT</td> </tr> <tr> <td>29011094</td> <td>PC1700-15/OE/HT</td> </tr> </table>	<i>Art. no.</i>	<i>Designation</i>	29011091	PC1700-3/OE/HT	29011092	PC1700-6/OE/HT	29011094	PC1700-15/OE/HT	Open ends	Supply voltage connection Power supply unit PS2020	
		<i>Art. no.</i>	<i>Designation</i>									
		29011091	PC1700-3/OE/HT									
29011092	PC1700-6/OE/HT											
29011094	PC1700-15/OE/HT											
Interface module of RS422 to USB IF2001/USB												
Interface module for Industrial Ethernet connection IF2035-PROFINET IF2035-EIP IF2035-EtherCAT (not for ILD1710)												
ILD1750-xxBL ILD1750-xxDR												
ILD1760-1000												

Other cables

Cable diameter:	6.7 mm
Drag chain:	yes
Robot:	no
Temperature range:	-40 ... 80 °C
Bending radius:	> 27 mm (fixed installation) > 51 mm (dynamic)

Input	Cables	Type	Connection possibilities and accessories					
2 x Sub-D (PC1700-x/ IF2008)	Adapter cables for 4-fold sensor connection Length 0.1 m <table> <tr> <td><i>Art. no.</i></td> <td><i>Designation</i></td> </tr> <tr> <td>2901528</td> <td>IF2008-Y-adapter cable</td> </tr> </table> 	<i>Art. no.</i>	<i>Designation</i>	2901528	IF2008-Y-adapter cable	Sub-D	Interface card for synchronous data acquisition IF2008PCIe / IF2008E	
		<i>Art. no.</i>	<i>Designation</i>					
2901528	IF2008-Y-adapter cable							
4-fold USB converter & parameter setting IF2004/USB								

optoNCDT 1910

see Connection possibilities optoNCDT 1900 on pg. 32.

IF2035: Interface module for Industrial Ethernet connection

- Connection of RS422 or RS485 interfaces to PROFINET / Ethernet/IP / EtherCAT
- Synchronization output for RS422 sensors
- 2 network connections for different network topologies
- Data rate up to 4 MBaud
- 4-fold oversampling (with EtherCAT)
- Ideal for confined spaces due to a compact housing and DIN rail mounting



EtherCAT®

EtherNet/IP®

PROFINET®

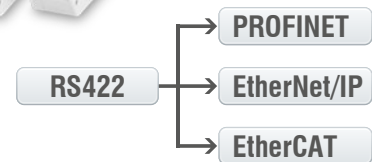

IF2008PCIe/IF2008E: Interface card for synchronous data acquisition

- IF2008PCIe - Basic PCB: 4 digital signals and 2 encoders
- IF2008E - Expansion board: 2x digital signals, 2x analog signals and 8x I/O signals
- Absolutely synchronous data acquisition for multi-channel applications (e.g. for planarity or thickness measurement)

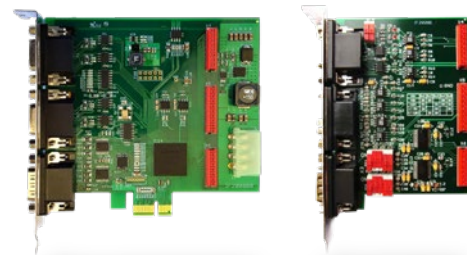

Interface card IF2008PCIe, IF2008E for individual signal processing

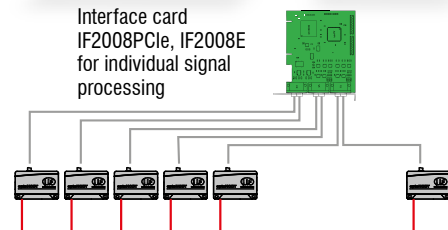

available from April 2024

Dual Processing Unit: Controller for D/A conversion and evaluation of up to 2 sensor signals

- Fast D/A conversion (16 bit, with a maximum of 100 kHz) of 2 digital input signals or calculation of 2 digital sensor signals
- Averaging functions and calculation of thickness, step, diameter, ovality and radial run out
- Trigger input
- Multi-function output
- Measurement value output via Ethernet, USB, analog output 4 ... 20 mA / 0 ... 5 V / 0 ... 10 V / ± 5 V / ± 10 V (scalable via web interface)
- 2x switching outputs for sensor or Dual Processing Unit status
- Parallel data output via three output interfaces
- Two filter possibilities
- Post-linearization of measured values or calculated values
- Easy parameter setting via web interface (controller and sensors)

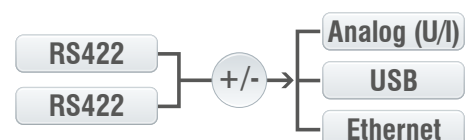

IF2008/ETH: Interface module for Ethernet connection of up to 8 sensors

- Integration of eight sensors or encoders with RS422 interface in Ethernet network
- Four programmable switching in-/outputs (TTL and HTL logic)
- Fast data acquisition and output up to 200 kHz
- Simple parameter set up via web interface



IC2001/USB Single-channel converter cable RS422/USB

- Conversion from RS422 to USB
- 5-core interface cable without outer shield
- Easy sensor connection via USB
- Supports baud rates from 9.6 kBaud to 1 MBaud
- Ideal for integration into plant and machinery



IF2001/USB: Interface module from RS422 to USB

- Conversion from RS422 to USB
- Signals and functions such as laser on/off, switch signals and function output
- Supports baud rates from 9.6 kBaud to 12 MBaud
- Robust aluminum housing
- Easy sensor connection via screw terminals (plug and play)
- Parameter setting (converter and sensors) via software



IF2004/USB: 4-fold interface module from RS422 to USB



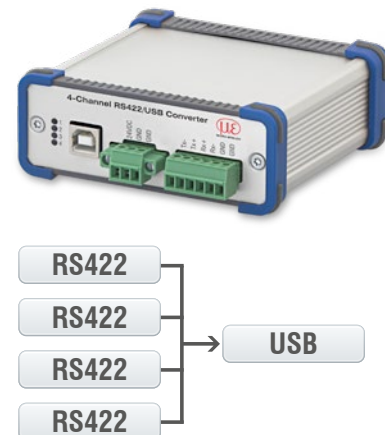

- Conversion of 4 digital signals (RS422) to USB
- 4x trigger inputs, 1x trigger output
- Synchronous data acquisition
- Parameter setting (converter and sensors) via software



Connection of 4 sensors via IF2008-Y-adapter cable

Protective housings for demanding environments

optoNCDT

SGH & SGHF models				SGHF-HT model
Protective housing Size S		Protective housing Size M		
SGH	SGHF	SGH	SGHF	
				
(140 x 140 x 71 mm)		(180 x 140 x 71 mm)		(260 x 180 x 154 mm)
Water-resistant housing protects the sensor from solvents and detergents.	Ideal with high ambient temperatures. The integrated air cooling of the housing offers optimum protection for the sensor.	Water-resistant housing protects the sensor from solvents and detergents.	Ideal with high ambient temperatures. The integrated air cooling of the housing offers optimum protection for the sensor.	Water-cooled protective housing with window and compressed-air connection for measurement tasks in ambient temperatures up to 200 °C. Maximum temperature of cooling water T(max) = 10 °C Minimum water flow rate Q(min) = 3 liters/min
Size S suitable for ILD1750-20BL ILD1750-200BL ILD2300-2 / -2LL / -2BL ILD2300-5 / -5BL ILD2300-10 / -10LL / -10BL ILD2300-20 / -20LL ILD2300-50 / -50LL ILD2300-100		Size M suitable for ILD1750-500BL ILD1750-750BL ILD2300-200 ILD2300-300 ILD2310-10 ILD2310-20 ILD2310-40		Suitable for ILD1710-50 / -50BL ILD1710-1000 / -1000BL ILD1750-500BL ILD1750-750BL ILD2300-200 ILD2300-300 ILD2310-10 ILD2310-20 ILD2310-40 ILD2310-50BL

Protective SGHF ILD1900
 <p>available from April 2024</p> <p>Compact protective housing which is simply attached to the sensor. The protective housing has an air purge for cleaning the protective windows. It also cools the sensor.</p>
<p>Suitable for</p> <p>ILD1900-2 / -2LL</p> <p>ILD1900-6 / -6LL</p> <p>ILD1900-10 / -10LL</p> <p>ILD1900-25 / -25LL</p> <p>ILD1900-50 / -50LL</p> <p>ILD1900-100</p> <p>ILD1900-200</p> <p>ILD1900-500</p>

sensorTOOL

The Micro-Epsilon sensorTOOL is a powerful software that is used to operate one or more optoNCDT sensors. The sensorTOOL can be used to access the sensor connected to the PC, display its complete data stream and save it in a file (in Excel-compatible CSV format). The sensor is configured via its web interface.

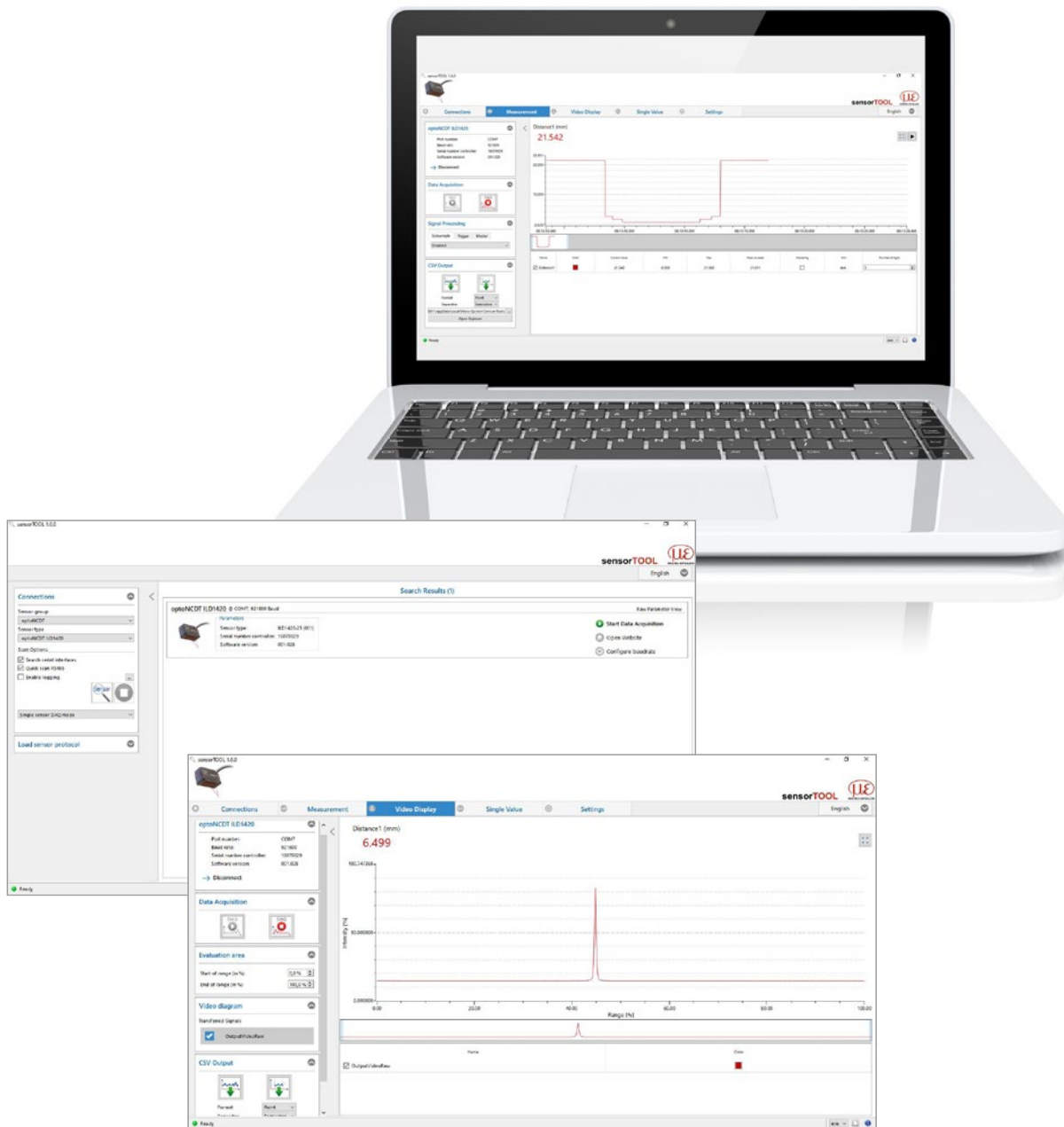

Free download

All software tools, drivers and documented driver DLL for easy integration of the sensors into existing or internally-generated software are available free of charge under www.micro-epsilon.de/download

Sensors and Systems from Micro-Epsilon



Sensors and systems for displacement, distance and position



Sensors and measurement devices for non-contact temperature measurement



Measuring and inspection systems for metal strips, plastics and rubber

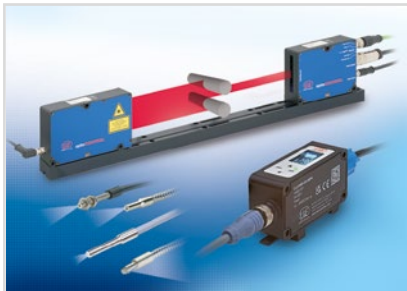

Optical micrometers and fiber optics, measuring and test amplifiers



Color recognition sensors, LED analyzers and inline color spectrometers



3D measurement technology for dimensional testing and surface inspection