











More Precision

confocalDT // Confocal chromatic sensor system



The new confocal controller for industrial applications

confocalDT IFC242x

-  Measuring rate up to 10 kHz
-  **INTER FACE** Ethernet / EtherCAT / RS422 / PROFINET / Ethernet/IP / Analog
-  Fast surface compensation
-  Configuration via web interface
-  Submicron resolution
-  Thickness measurement of multi-layer materials
-  Synchronous two-sided thickness measurement
-  Robust design with passive cooling



The confocalDT 2421/22 controllers set the industrial standard in precise, confocal measurement technology. Available as either a single- or a dual-channel version, these measuring systems are a low cost solution especially for serial applications. The active exposure regulation of the CCD line enables fast and accurate compensation of varying surfaces.

The controller can be operated with any IFS sensor and is available as a standard version for distance and thickness measurements or as a multi-peak version for multi-layer measurements. Using a special calculation function, the confocalDT 2422 dual-channel version evaluates both channels. Measurement acquisition is synchronous and can be carried out while exploiting the full measuring rate for both channels.

Due to a user-friendly web interface, no additional software is necessary to configure the controller and the sensors. Data output is via Ethernet, EtherCAT, RS422 or analog output.



Settings are made via the web interface. For thickness measurements, materials are stored in an expandable materials database.



Two sensors can be directly connected to a confocal IFC2422 controller.

Model	IFC2421	IFC2421MP	IFC2422	IFC2422MP
Resolution	Ethernet/EtherCAT	1 nm		
	RS422	18 bit		
	Analog	16 bits (teachable)		
Measuring rate	continuously adjustable from 100 Hz to 10 kHz ¹⁾			
Linearity	typ. $\pm 0.025\%$ FSO (depends on sensor)			
Multi-peak measurement	1 layer	5 layers	1 layer	5 layers
Light source	internal white LED			
No. of characteristic curves	up to 20 characteristic curves for different sensors per channel, selection via table in the menu			
Permissible ambient light ²⁾	30,000 lx			
Synchronization	yes			
Supply voltage	24 VDC $\pm 15\%$			
Power consumption	approx. 10 W			
Signal input	sync-in / trig-in; 2x encoders (A+, A-, B+, B-, index) or 3x encoders (A+, A-, B+, B-)			
Digital interface	Ethernet; EtherCAT; RS422; PROFINET ³⁾ ; EtherNet/IP ³⁾			
Analog output	Current: 4 ... 20 mA; voltage: 0 ... 10 V (16 bit D/A converter)			
Switching output	Error1-Out, Error2-Out			
Digital output	sync-out			
Connection	Optical	pluggable optical fiber via E2000 socket, length 2 m ... 50 m, min. bending radius 30 mm)		
	Electrical	3-pin supply terminal strip; encoder connection (15-pin, HD-sub socket, max. cable length 3 m, 30 m with external encoder supply); RS422 connection socket (9-pin, Sub-D, max. cable length 30 m); 3-pin output terminal strip (max. cable length 30 m); 11-pin I/O terminal strip (max. cable length 30 m); RJ45 socket for Ethernet (out) / EtherCAT (in/out) (max. cable length 100 m)		
Installation	Free-standing, DIN rail mounting			
Temperature range	Storage	-20 ... +70 °C		
	Operation	+5 ... +50 °C		
Shock (DIN EN 60068-2-27)	15 g / 6 ms in XYZ axis, 1000 shocks each			
Vibration (DIN EN 60068-2-6)	2 g / 20 ... 500 Hz in XYZ axis, 10 cycles each			
Protection class (DIN EN 60529)	IP40			
Material	Aluminum			
Weight	approx. 1.8 kg		approx. 2.25 kg	
Compatibility	compatible with all confocalDT sensors			
No. of measurement channels ⁴⁾	1		2	
Control and indicator elements	Multifunction button (two adjustable functions and reset to factory setting after 10 s); 5x LEDs for intensity, range, status and supply voltage			

FSO = Full Scale Output

¹⁾ Full measuring range up to 8 kHz. Sensor-dependent up to 80% FSO between 9 and 10 kHz.

²⁾ Illuminant: light bulb

³⁾ Connection via interface module (see accessories)

⁴⁾ No loss of intensity and linearity due to two synchronous measurement channels

IFC2421 Controller

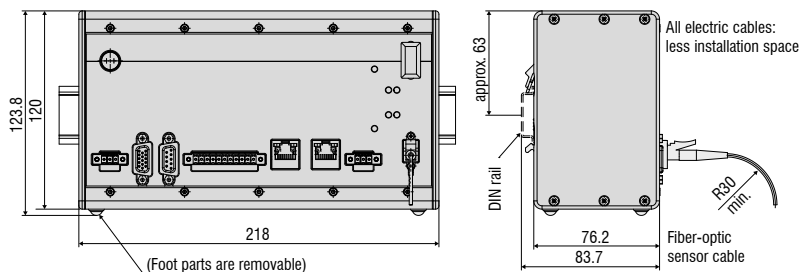

IFC2422 Controller

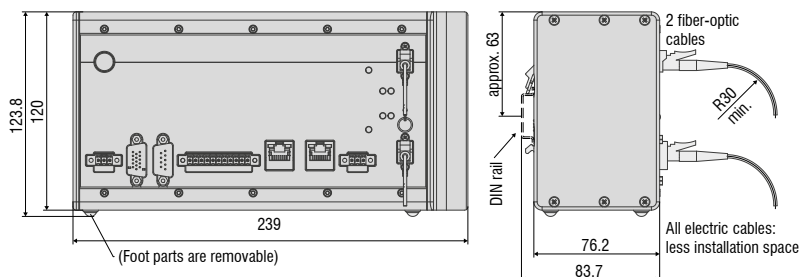

System design confocalDT

Cable concepts for every application

The connection options are diverse and can be adapted to your plant or machine concept.

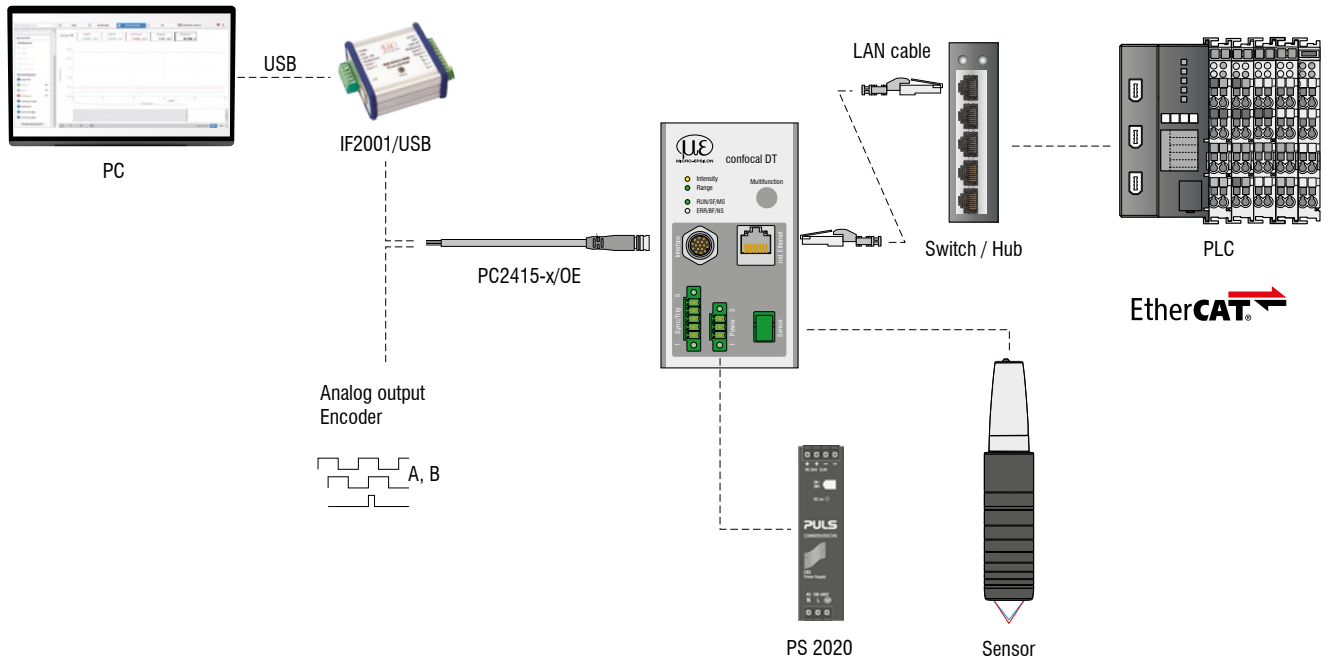
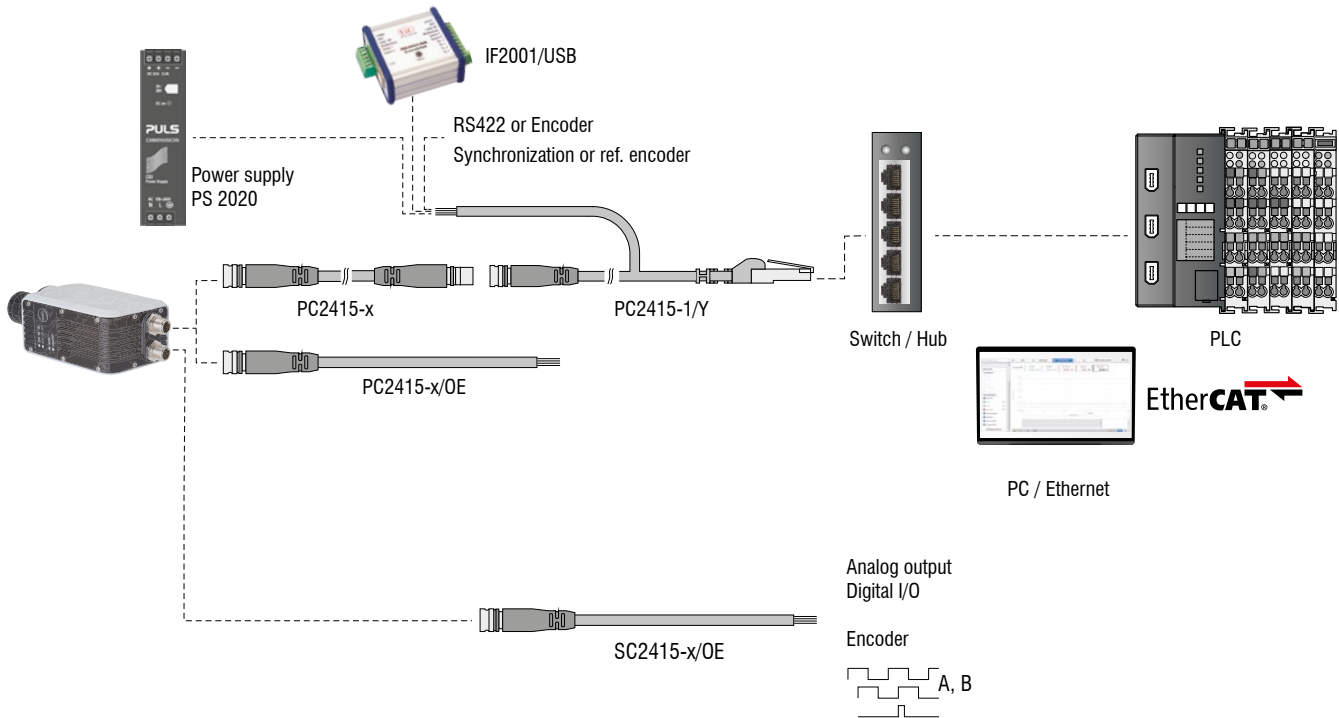

The confocalDT system consists of:

- Sensor IFS240x
- Controller IFC24xx
- Fiber optic cable C24xx

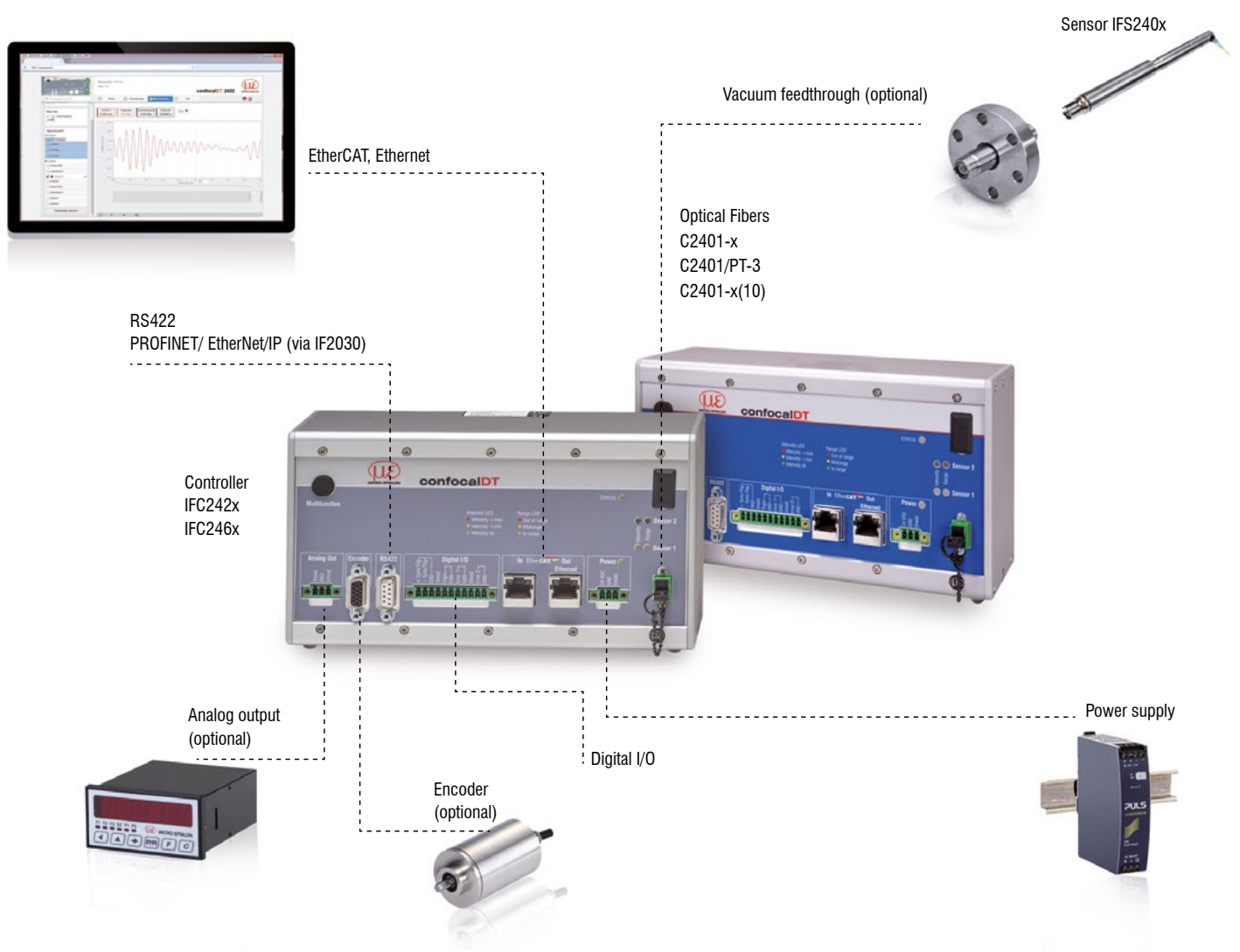

Customer-specific modifications confocalDT

Customer-specific modifications

Application examples are often found where the standard versions of the sensors and the controllers are performing at their limits. To facilitate such special tasks, it is possible to customize the sensor design and to adjust the controller accordingly. Common requests for modifications include changes in design, mounting options, customized cable lengths and modified measuring ranges.



Possible modifications

- Sensors with connector
- Cable length
- Vacuum suitability up to UHV
- Specific lengths
- Customer-specific mounting options
- Optical filter for ambient light compensation
- Housing material
- Measuring range / Offset distance

Vacuum setup

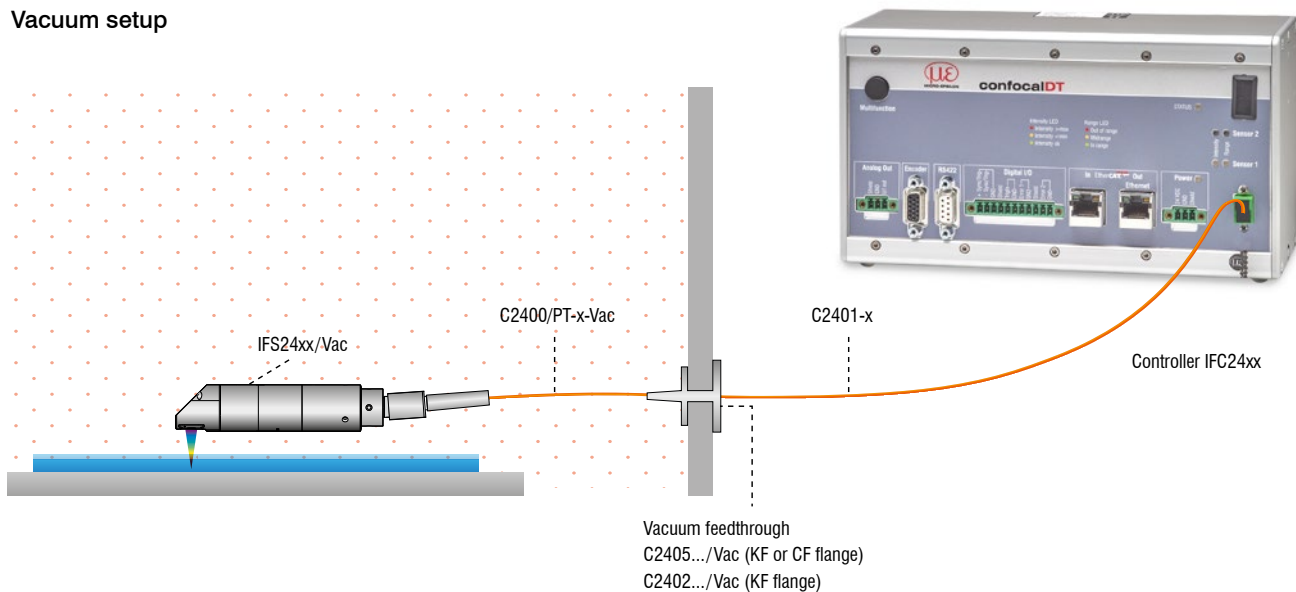

Accessories

Mounting adapter

Accessories: mounting adapter
MA2402 for sensors 2402

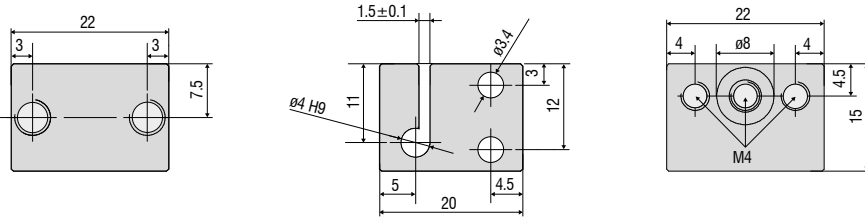

Accessories: mounting adapter
MA2403 for sensors 2403

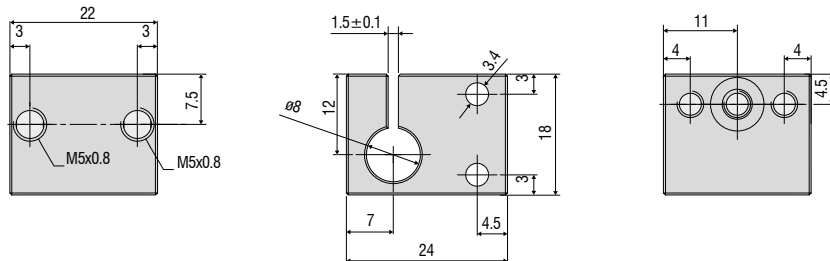

Accessories: mounting adapter
MA2404-12 for sensors IFS2404-2 / IFS2404/90-2 / IFS2407-0,1

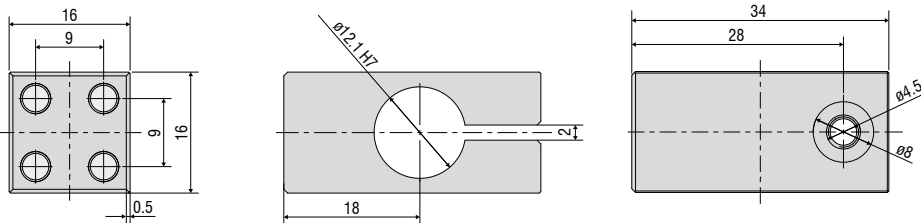

Accessories: mounting adapter
MA2400 for sensors IFS2405 / IFS2406 / IFS2407 (consisting of a mounting block and a mounting ring)

Mounting block

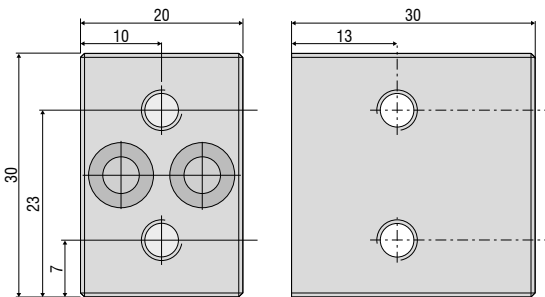

Mounting ring

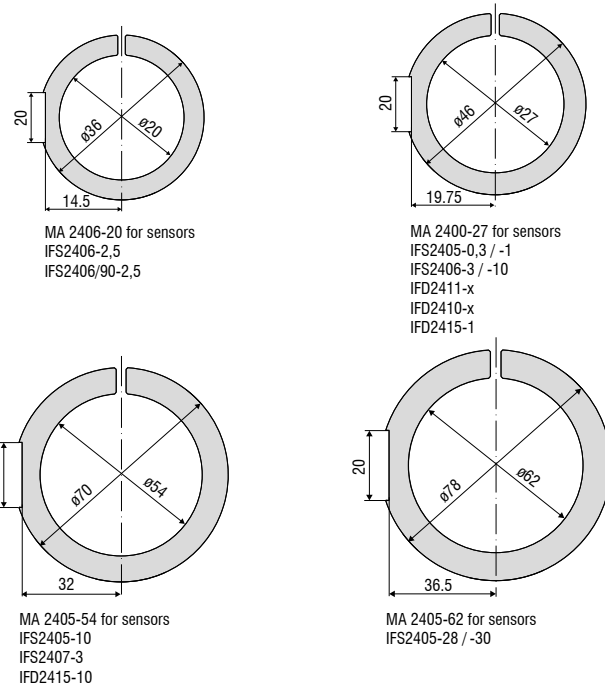

Adjustable mounting adapters

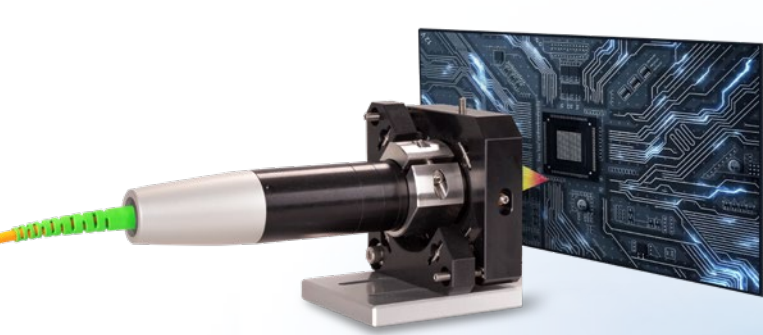

JMA-xx mounting adapter
for distance measurements

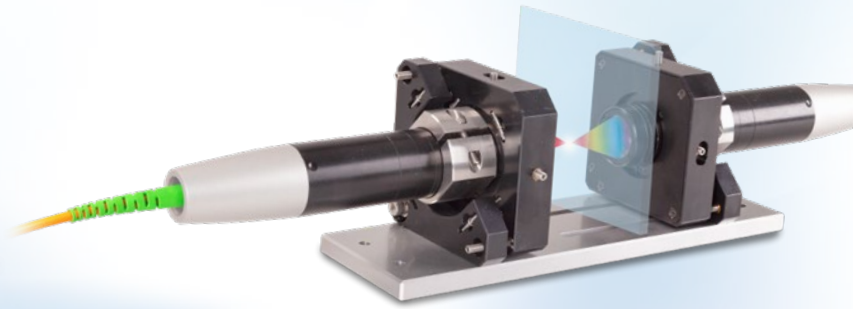

JMA-Thickness mounting adapter
for two-sided thickness measurements

The adjustable JMA mounting adapter simplifies the alignment and fine adjustment of confocal sensors. The sensors are integrated and aligned directly in the machine together with the adapter. This corrects, e.g. minor deviations caused by mounting and compensates for tilted measuring objects. With two-sided thickness measurements, the JMA-Thickness mounting adapter supports the fine alignment of the two measuring points.

1 Max. shift in X ± 2 mm



2 Max. shift in Y ± 2 mm

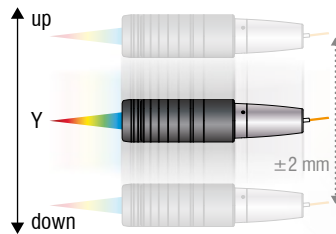

3 Max. tilt angle in X $\pm 4^\circ$



4 Max. tilt angle in Y $\pm 4^\circ$

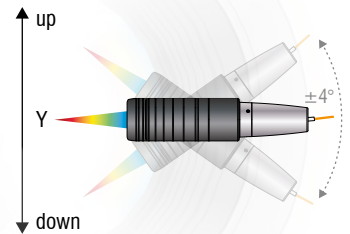

Dimensions

Adjustable mounting adapter JMA

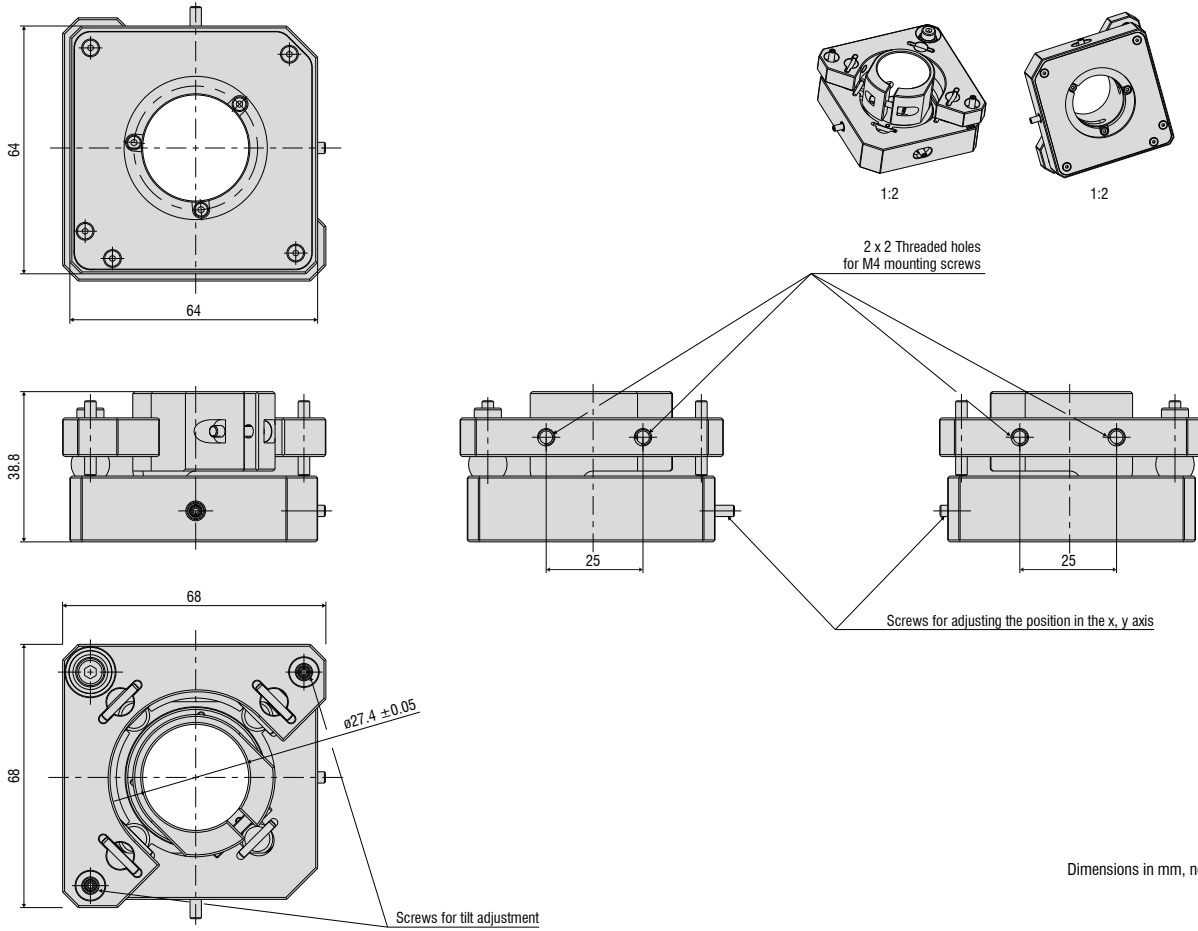

Dimensions in mm, not to scale

Holder for smaller sensor diameters

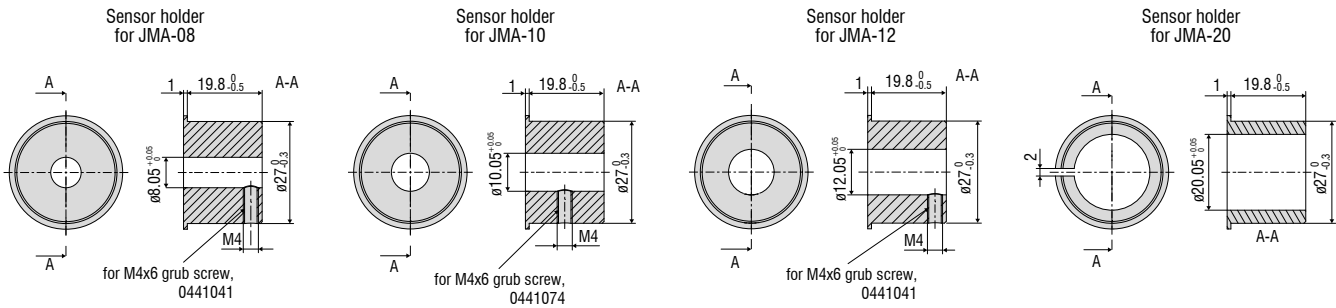

Mounting plate JMP for JMA-Thickness

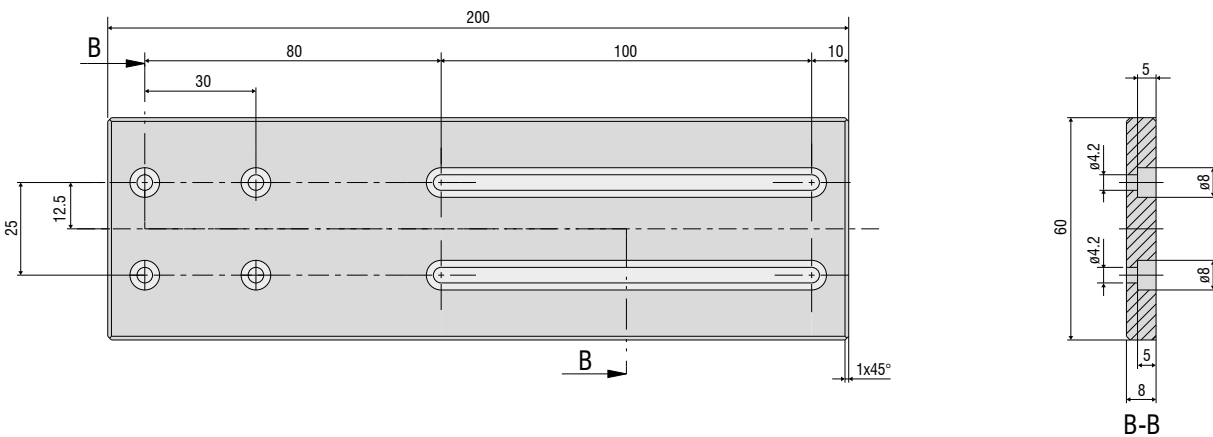

Accessories

Mounting adapter for individual sensors

Manual adjustment mechanism for easy and fast adjustment

Optimal sensor alignment for best possible measurement results

Ideally suitable for machine integration



Particularly for high resolution sensors with a small tilt angle, perpendicular installation is required. The JMA-xx mounting adapter enables fine alignment of the sensor to the target via the simple adjustment mechanism. This makes it easy to compensate for minor mounting deviations or tilted measuring objects.

Scope of supply

- 1 JMA-xx
- 1 sensor holder for smaller diameters (not with JMA-27)
- 1 hexagon screwdriver for positioning
- Assembly instructions

Model	JMA-08	JMA-12	JMA-20	JMA-27
Tilting range	X	±4° (continuously adjustable)		
	Y	±4° (continuously adjustable)		
Shifting range	X	±2 mm (continuously adjustable)		
	Y	±2 mm (continuously adjustable)		
Shock (DIN EN 60068-2-27)	15 g / 6 ms in XYZ axis, 1000 shocks each			
Vibration (DIN EN 60068-2-6)	2 g / 20 ... 500 Hz in XYZ axis, 10 cycles each			
Adjustment mechanism	Screw setting mechanism via M3x0.25 screw with hexagon socket 1.5			
Installation	2x 2 mounting holes for M4x1			
Sensor mounting	Radial clamping for ø 8 mm	Radial clamping for ø 12 mm	Radial clamping for ø 20 mm	Radial clamping for ø 27 mm
Compatibility	confocalDT: IFS2403 series	confocalDT: IFS2404-2 IFS2407-0,1 IFS2407-0,8	confocalDT: IFS2406-2,5/VAC interferoMETER: IMP-TH70	confocalDT: IFS2405-0,3 IFS2405-1 IFS2406-3 IFS2406-10 IFD2411-x

Application examples:

Alignment

Subsequent correction of the mounting position

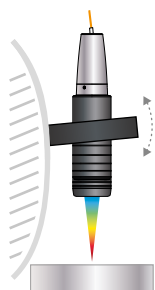

Compensates for incorrect target position

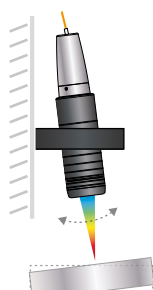

Positioning

Shifting the sensor to target area

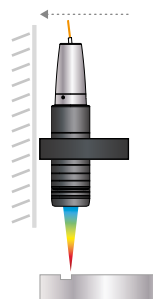

Accessories

Mounting adapter for two-sided thickness measurements

Optimal alignment of the optical axes enables high precision in two-sided thickness measurements

Pre-assembled for easy installation and fast commissioning

Ideally suitable for machine integration

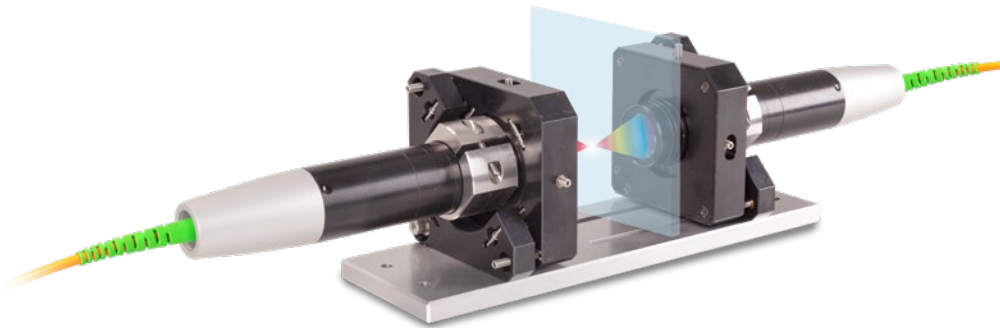

For two-sided thickness measurements, the JMA-Thickness mounting adapter supports the alignment of the measuring points to one another. This means that the measuring points are arranged absolutely congruent to each other so that the sensors are positioned exactly on an optical axis. This prevents measurements at an offset and a reliable measurement result is achieved with the highest possible precision.

When delivered, the two mounting adapters are pre-mounted on a mounting plate and aligned with one another. This simplifies installation and the measuring system can be put into operation more quickly. After installation into the machine, the plate can be removed, if necessary.

Scope of supply

- 2 JMA-xx
- 1 JMP mounting plate
- 1 hexagon screwdriver 1.5 mm
- 1 Allen wrench 2.5 mm
- 1 Allen wrench 3.0 mm
- 1 Assembly instructions
- 2 optional reducing sleeves
(depending on the package and the corresponding sensor)

Model	JMA-Thickness	-08	-12	-20	-27
Shock (DIN EN 60068-2-27)		15 g / 6 ms in XYZ axis, 1000 shocks each			
Vibration (DIN EN 60068-2-6)		2 g / 20 ... 500 Hz in XYZ axis, 10 cycles each			
Adjustment mechanism		Screw setting mechanism via M3x0.25 screw with hexagon socket 1.5			
Sensor mounting		Radial clamping for ø 8 mm	Radial clamping for ø 12 mm	Radial clamping for ø 20 mm	Radial clamping for ø 27 mm
Compatibility		confocalDT: IFS2403 series	confocalDT: IFS2404-2 IFS2407-0,1	confocalDT: IFS2406-2,5/VAC interferoMETER: IMP-TH70	confocalDT: IFS2405-0,3 IFS2405-1 IFS2406-3 IFS2406-10 IFD2411-x

More precision with two-sided thickness measurements



Without JMA-Thickness:
Measurement error with tilted target

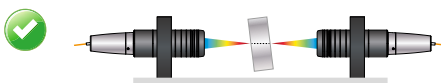

With JMA-Thickness:
Measures exactly at the opposite position

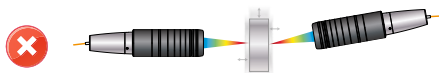

Without JMA-Thickness:
Incorrect thickness measurement with vibrations

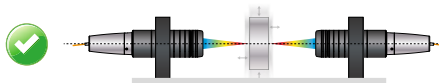

With JMA-Thickness:
Sensors are on one optical axis –
provides stability even with vibrating objects



Without JMA-Thickness:
Sensors positioned incorrectly – no thickness measurement possible

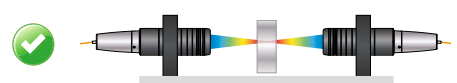

With JMA-Thickness:
Optimal positioning support – object visible for both sensors

Accessories

Cables and connectors

Software

IFD24xx-Tool Software demo tool included

Light source accessories

IFL2422/LED Lamp module for IFC2422 and IFC2466
 IFL24x1/LED Lamp module for IFC2421 and IFC2465

Optical fiber extension for sensors

CE2402 cable with 2x E2000/APC connectors
 CE2402-x Extension for optical fiber (3 m, 10 m, 13 m, 30 m, 50 m)
 CE2402/PT3-x Optical fiber extension with protection tube for mechanical stress
 (3 m, 10 m, customer-specific length up to 50 m)

Optical fibers for IFS2404/IFS2404-2 and IFS2404/90-2 sensors

C2404-x Optical fiber with FC/APC and E2000/APC connectors
 Fiber core diameter 20 μm (2 m)

Optical fibers for IFS2405/IFS2406/2407-0,1/ IFS2407-3/IFD2411-x sensors

C2401 cable with FC/APC and E2000/APC connectors
 C2401-x Optical fiber (3 m, 5 m, 10 m, customer-specific length up to 50 m)
 C2401/PT3-x Optical fiber with protection tube for mechanical stress
 (3 m, 5 m, 10 m, customer-specific length up to 50 m)
 C2401-x(01) Optical fiber core diameter 26 μm (3 m, 5 m, 15 m)
 C2401-x(10) Drag-chain suitable optical fiber (3 m, 5 m, 10 m)

C2400 cable with 2x FC/APC connectors

C2400-x Optical fiber (3 m, 5 m, 10 m, customer-specific length up to 50 m)
 C2400/PT-x Optical fiber with protection tube for mechanical stress
 (3 m, 5 m, 10 m, customer-specific length up to 50 m)
 C2400/PT-x-Vac Optical fiber with protection tube suitable for use in vacuum
 (3 m, 5 m, 10 m, customer-specific length up to 50 m)

Cables for IFD2410 /2415 sensors

PC2415-x Supply/interface cable, drag-chain suitable,
 3 m, 6 m, 9 m, 15 m
 PC2415-x/OE Supply/interface cable open ends, drag-chain suitable,
 3 m, 6 m, 9 m, 15 m
 PC2415-1/Y Supply/interface cable Y, open ends and RJ45 plug,
 drag-chain suitable, 1 m
 SC2415-x/OE Multifunction cable, open ends, drag-chain suitable,
 3 m, 6 m, 9 m, 15 m

Cables for IFD2411 sensors

SC2415-x/OE Multifunction cable, open ends, drag-chain suitable, 3 m, 6 m, 9 m, 15 m
 C2401-x Optical fiber (3 m, 5 m, 10 m, customer-specific length up to 50 m)



Optical fiber C2401-x



Optical fiber with coating C2401/PT3-x



Drag-chain suitable optical fiber C2401-x(10)

Optical fibers for IFS2407/90-0,3 sensors

C2407-x Optical fiber with DIN connector and E2000/APC (2 m, 5 m)

Vacuum feedthrough

- C2402/Vac/KF16 Vacuum feedthrough with optical fiber, 1 channel, vacuum side FC/APC non-vacuum side E2000/APC, clamping flange KF 16
- C2405/Vac/1/KF16 Vacuum feedthrough on both sides FC/APC socket, 1 channel, clamping flange type KF 16
- C2405/Vac/1/CF16 Vacuum feedthrough on both sides FC/APC socket, 1 channel, flange type CF 16
- C2405/Vac/6/CF63 Vacuum feedthrough FC/APC socket, 6 channels, flange type CF 63

Other accessories

- SC2471-x/USB/IND Connector cable IFC2461/71, 3 m, 10 m, 20 m
- SC2471-x/IF2008 Connector cable IFC2461/71-IF2008, 3 m, 10 m, 20 m
- PS2020 Power supply 24V / 2.5A
- EC2471-3/OE Encoder cable, 3m
- IF2030/PNET Interface module for PROFINET connection
- IF2030/ENETIP Interface module for EtherNet/IP connection

Optical fiber

Temperature range : -50 °C to 90 °C

Bending radius: 30/40 mm

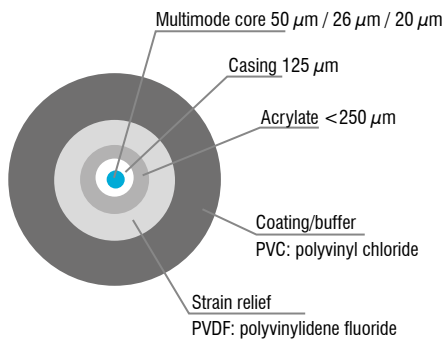

E2000/APC standard connector

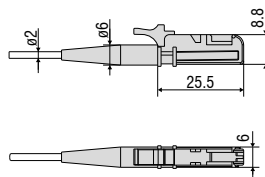

FC/APC standard connector

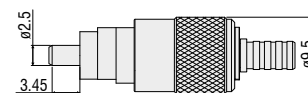

DIN connector

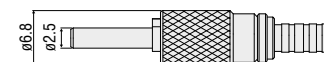

Accessories

Interface modules

Module	IFC2410	IFC2411	IFC2415	IFC242x	IFC246x
IF2001/USB Single-channel RS422/USB converter cable	✓	✓	✓	✓	✓
IF2004/USB RS422/USB converter to convert up to 4 digital signals to USB	⊘	⊘	⊘	✓	✓
IF2008/ETH Interface module for Ethernet connection for up to 8 sensors	⊘	⊘	⊘	✓	✓
IF2008PCIE Interface card for multiple sensor signals; analog and digital interfaces	⊘	⊘	⊘	✓	✓
IF2035/PNET Interface module for Industrial Ethernet connection (PROFINET)	⊘	⊘	⊘	✓	✓
IF2035/ENETIP Interface module for Industrial Ethernet connection (EtherNet/IP)	⊘	⊘	⊘	✓	✓

IF2001/USB converter RS422 to USB

The RS422/USB converter converts the digital signals of a confocal controller into a USB data packet. The sensor and the converter are connected via the RS422 interface of the converter. Data output is done via USB interface. The converter loops through further signals and functions such as laser on/off, switch signals and function output. The connected controllers and the converter can be programmed through software.

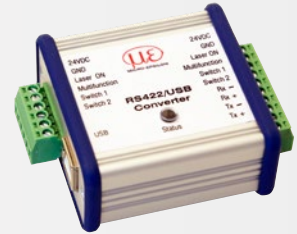

Special features

- Robust aluminum housing
- Easy sensor connection via screw terminals (plug and play)
- Conversion from RS422 to USB
- Supports baud rates from 9.6 kBaud to 12 MBaud



IF2004/USB: 4-channel converter from RS422 to USB

The RS422/USB converter is used for transforming digital signals of up to four confocal controllers into USB data signals. The converter has four trigger inputs and a trigger output for connecting additional converters. Data is output via an USB interface. The connected controllers and the converter can be programmed through software. The COM interfaces can be used individually and can be switched.



Special features

- 4x digital signals via RS422
- 4x trigger inputs, 1x trigger output
- Synchronous data acquisition
- Data output via USB

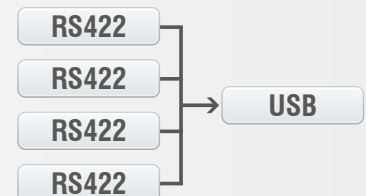

IF2008/ETH

IF2008/ETH Interface module for Ethernet connection with up to 8 sensors

The IF2008/ETH integrates up to eight sensors and/or encoders with an RS422 interface into an Ethernet network. Four programmable switching in-/outputs (TTL and HTL logic) are available.

10 indicator LEDs directly on the module show both the channel and the device status. In addition, acquisition and output of data via Ethernet is in addition performed at high speeds up to 200 kHz. Parameter setting of the interface module can be easily done via the web interface.



IF2008PCle/IF2008E

Interface card for synchronous data acquisition

Absolute synchronous data acquisition is a decisive factor for the deflection or straightness measurement using several controllers. The IF2008PCle interface card is designed for installation in PCs and enables the synchronous acquisition of four digital sensor signals and two encoders. The data is stored in a FIFO memory in order to enable resource-saving processing in blocks in the PC. The IF2008E expansion board enables to detect in addition two digital controller signals, two analog controller signals and eight I/O signals.

Special features

- IF2008PCle - Basic printed circuit board: 4 digital signals and 2 encoders
- IF2008E - Expansion board: 2x digital signals, 2x analog signals and 8x I/O signals

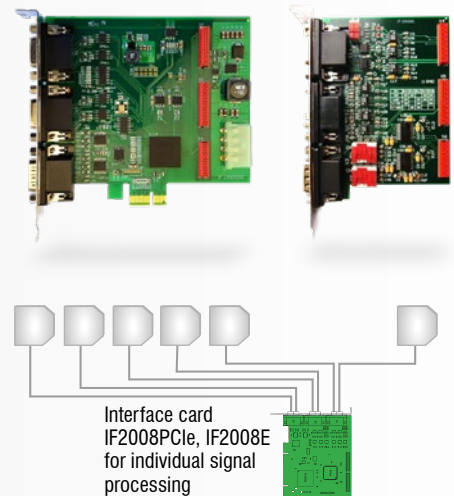

IF2035

Interface module for Industrial Ethernet connection

The IF2035 interface modules are designed for easy connection of Micro-Epsilon sensors to Ethernet-based fieldbuses. The IF2035 is compatible with sensors that output data via an RS422 or RS485 interface and supports the common Industrial Ethernet protocols EtherCAT, PROFINET and EtherNet/IP.

These modules operate on the sensor side with up to 4 MBd and have two network connections for different network topologies. In addition, the IF2035-EtherCAT offers a 4-fold oversampling function, which enables faster measurements than the bus cycle allows, if required. Installation in control cabinets is via a DIN rail.

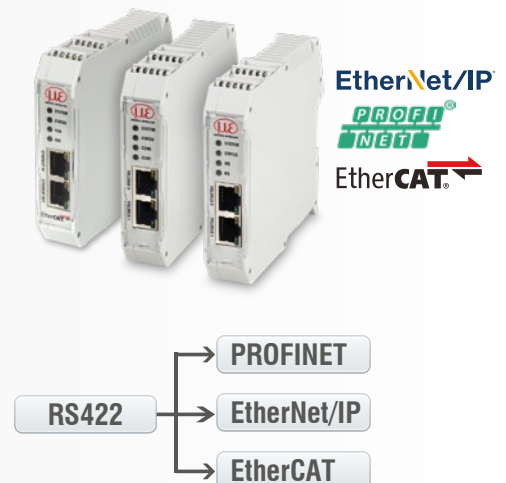

Sensors and Systems from Micro-Epsilon



Sensors and systems for displacement, distance and position



Sensors and measurement devices for non-contact temperature measurement



Measuring and inspection systems for metal strips, plastics and rubber

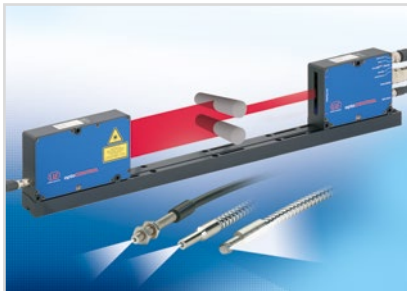

Optical micrometers and fiber optics, measuring and test amplifiers



Color recognition sensors, LED analyzers and inline color spectrometers



3D measurement technology for dimensional testing and surface inspection