

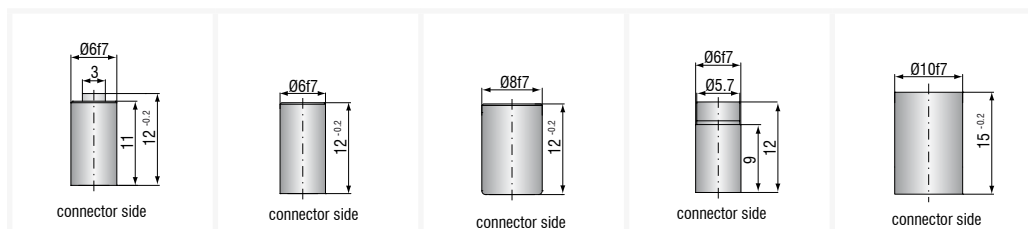

More Precision

capa**N**CDT // Capacitive displacement sensors and systems





Sensor type		CS005	CS02	CS05	CSE05	CS08
Article No.		6610083	6610051	6610053	6610102	6610080
Measuring range	reduced	0.025 mm	0.1 mm	0.25 mm	0.25 mm	0.4 mm
	nominal	0.05 mm	0.2 mm	0.5 mm	0.5 mm	0.8 mm
	extended	0.1 mm	0.4 mm	1 mm	1 mm	1.6 mm
Linearity ¹⁾		≤ ±0.15 μm	≤ ±0.4 μm	≤ ±0.15 μm	≤ ±0.5 μm	≤ ±0.4 μm
		≤ ±0.3 % FSO	≤ ±0.2 % FSO	≤ ±0.03 % FSO	≤ ±0.1 % FSO	≤ ±0.2 % FSO
Resolution ^{1) 2)}	static 2 Hz	0.0375 nm	0.15 nm	0.375 nm	0.375 nm	0.6 nm
	dynamic 8.5 kHz	1 nm	4 nm	10 nm	10 nm	16 nm
Temperature stability	Zero ⁵⁾	-60 nm/K	-60 nm/K	-60 nm/K	-60 nm/K	-60 nm/K
	Sensitivity	-0.5 nm/K	-2 nm/K	-5 nm/K	-5 nm/K	-8 nm/K
Temperature range	Operation	-50 ... +200 °C	-50 ... +200 °C	-50 ... +200 °C	-50 ... +200 °C	-50 ... +200 °C
	Storage	-50 ... +200 °C	-50 ... +200 °C	-50 ... +200 °C	-50 ... +200 °C	-50 ... +200 °C
Humidity ³⁾		0 % ... 95 % r.H.	0 % ... 95 % r.H.	0 % ... 95 % r.H.	0 % ... 95 % r.H.	0 % ... 95 % r.H.
Dimensions		Ø6 × 12 mm	Ø6 × 12 mm	Ø8 × 12 mm	Ø6 × 12 mm	Ø10 × 15 mm
Active measuring area		Ø1.3 mm	Ø2.3 mm	Ø3.9 mm	Ø3.9 mm	Ø4.9 mm
Guard ring width		0.8 mm	1 mm	1.4 mm	0.8 mm	1.6 mm
Minimum target diameter		Ø3 mm	Ø5 mm	Ø7 mm	Ø6 mm	Ø9 mm
Weight		2 g	2 g	4 g	2 g	7 g
Material	Housing	NiFe ⁴⁾ (magn.)	NiFe (magn.)	NiFe (magn.)	NiFe (magn.)	NiFe (magn.)
Connection		type C	type C	type C	type C	type C
Mounting		clamping	clamping	clamping	clamping	clamping

FSO = Full Scale Output

¹⁾ Valid with reference controller, relates to standard measuring range

²⁾ RMS value of the signal noise

³⁾ Non condensing

⁴⁾ Titanium version available

⁵⁾ Sensor mounted in the mid of clamping area

Sensors

The sensors are designed as guard ring capacitors. They are connected to the signal conditioning electronics with a triaxial cable. The sensor cable is connected to the sensor using a high quality connector. All standard sensors can be used within a maximum deviation of 0.3 % without recalibration. Individually matched special sensors are produced on request.

Measuring range expansion/reduction

The capaNCDT controller can optionally be configured so that the standard measuring ranges of the sensors are reduced by half or expanded by the factor of 2. The reduction increases the accuracy while the measuring range expansion reduces the accuracy.

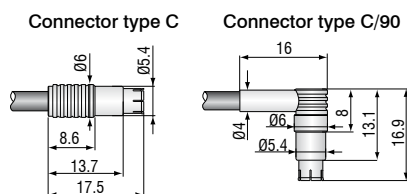

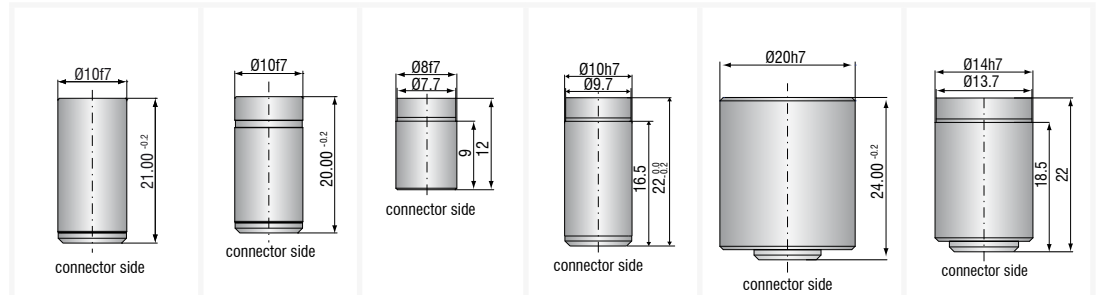

Sensor type		CS1	CS1HP	CSE1	CSE1,25	CS2	CSE2
Article No.		6610054	6610074	6610103	6610161	6610052	6610104
Measuring range	reduced	0.5 mm	0.5 mm	0.5 mm	0.625 mm	1 mm	1 mm
	nominal	1 mm	1 mm	1 mm	1.25 mm	2 mm	2 mm
	extended	2 mm	2 mm	2 mm	2.5 mm	4 mm	4 mm
Linearity ¹⁾		$\leq \pm 1.5 \mu\text{m}$	$\leq \pm 1.5 \mu\text{m}$	$\leq \pm 1 \mu\text{m}$	$\leq \pm 1.25 \mu\text{m}$	$\leq \pm 1 \mu\text{m}$	$\leq \pm 2 \mu\text{m}$
		$\leq \pm 0.15 \% \text{ FSO}$	$\leq \pm 0.15 \% \text{ FSO}$	$\leq \pm 0.1 \% \text{ FSO}$	$\leq \pm 0.1 \% \text{ FSO}$	$\leq \pm 0.05 \% \text{ FSO}$	$\leq \pm 0.1 \% \text{ FSO}$
Resolution ^{1) 2)}	static 2 Hz	0.75 nm	0.75 nm	0.75 nm	0.9 nm	1.5 nm	1.5 nm
	dynamic 8.5 kHz	20 nm	20 nm	20 nm	25 nm	40 nm	40 nm
Temperature stability	Zero ⁵⁾	-170 nm/K	-60 nm/K	-60 nm/K	-65 nm/K	-170 nm/K	-170 nm/K
	Sensitivity	-32 nm/K	-10 nm/K	-10 nm/K	-50 nm/K	-64 nm/K	-64 nm/K
Temperature range	Operation	-50 ... +200 °C	-50 ... +200 °C	-50 ... +200 °C	-50 ... +200 °C	-50 ... +200 °C	-50 ... +200 °C
	Storage	-50 ... +200 °C	-50 ... +200 °C	-50 ... +200 °C	-50 ... +200 °C	-50 ... +200 °C	-50 ... +200 °C
Humidity ³⁾		0 % ... 95 % r.H.	0 % ... 95 % r.H.	0 % ... 95 % r.H.	0 % ... 95 % r.H.	0 % ... 95 % r.H.	0 % ... 95 % r.H.
Dimensions		$\varnothing 10 \times 21 \text{ mm}$	$\varnothing 10 \times 20 \text{ mm}$	$\varnothing 8 \times 12 \text{ mm}$	$\varnothing 10 \times 22 \text{ mm}$	$\varnothing 20 \times 24 \text{ mm}$	$\varnothing 14 \times 22 \text{ mm}$
Active measuring area		$\varnothing 5.7 \text{ mm}$	$\varnothing 5.7 \text{ mm}$	$\varnothing 5.7 \text{ mm}$	$\varnothing 6.5 \text{ mm}$	$\varnothing 7.9 \text{ mm}$	$\varnothing 8.0 \text{ mm}$
Guard ring width		1.5 mm	1.5 mm	0.9 mm	1.6 mm	4.4 mm	2.7 mm
Minimum target diameter		$\varnothing 9 \text{ mm}$	$\varnothing 9 \text{ mm}$	$\varnothing 8 \text{ mm}$	$\varnothing 10 \text{ mm}$	$\varnothing 17 \text{ mm}$	$\varnothing 14 \text{ mm}$
Weight		8 g	8 g	3.5 g	8.2 g	50 g	20 g
Material	Housing	1.4404 ⁴⁾ (non-magn.)	NiFe (magn.)	NiFe (magn.)	1.4404 (non-magn.)	1.4404 ⁴⁾ (non-magn.)	1.4404 (non-magn.)
Connection		type B	type B	type C	type B	type B	type B
Mounting		clamping	clamping	clamping	clamping	clamping	clamping

FSO = Full Scale Output

¹⁾ Valid with reference controller, relates to standard measuring range

²⁾ RMS value of the signal noise

³⁾ Non condensing

⁴⁾ Titanium version available

⁵⁾ Sensor mounted in the mid of clamping area

Mounting cylindrical sensors

All sensors can be installed as both freestanding and flush units.

The sensors can be clamped or fastened using a collet.

Connector type B

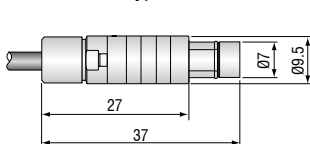

Connector type B/90

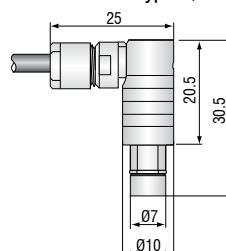

Mounting with set screw (plastic)

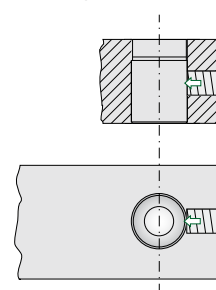

Mounting with collet

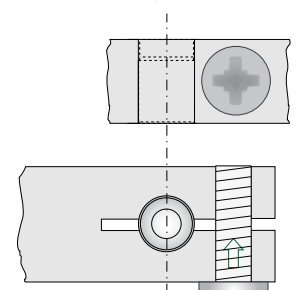

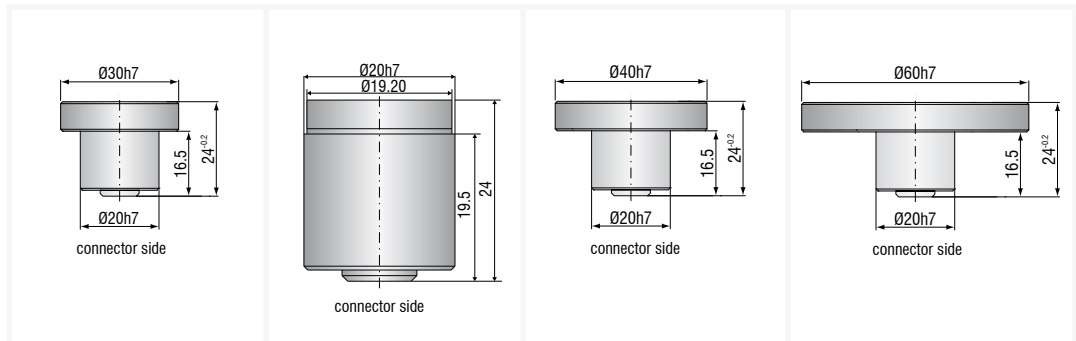

Sensor type		CS3	CSE3	CS5	CS10
Article No.		6610055	6610170	6610056	6610057
Measuring range	reduced	1.5 mm	1.5 mm	2.5 mm	5 mm
	nominal	3 mm	3 mm	5 mm	10 mm
	extended	6 mm	6 mm	10 mm	20 mm
Linearity ¹⁾		$\leq \pm 0.9 \mu\text{m}$	$\leq \pm 3 \mu\text{m}$	$\leq \pm 2.5 \mu\text{m}$	$\leq \pm 15 \mu\text{m}$
		$\leq \pm 0.03 \% \text{ FSO}$	$\leq \pm 0.1 \% \text{ FSO}$	$\leq \pm 0.05 \% \text{ FSO}$	$\leq \pm 0.15 \% \text{ FSO}$
Resolution ^{1) 2)}	static 2 Hz	2.25 nm	2.25 nm	3.75 nm	7.5 nm
	dynamic 8.5 kHz	60 nm	60 nm	100 nm	200 nm
Temperature stability	Zero ⁵⁾	-170 nm/K	-95 nm/K	-170 nm/K	-170 nm/K
	Sensitivity	-96 nm/K	-85 nm/K	-160 nm/K	-320 nm/K
Temperature range	Operation	-50 ... +200 °C	-50 ... +200 °C	-50 ... +200 °C	-50 ... +200 °C
	Storage	-50 ... +200 °C	-50 ... +200 °C	-50 ... +200 °C	-50 ... +200 °C
Humidity ³⁾		0 % ... 95 % r.H.	0 % ... 95 % r.H.	0 % ... 95 % r.H.	0 % ... 95 % r.H.
Dimensions		Ø30 × 24 mm	Ø20 × 24 mm	Ø40 × 24 mm	Ø60 × 24 mm
Active measuring area		Ø9.8 mm	Ø10 mm	Ø12.6 mm	Ø17.8 mm
Guard ring width		8 mm	4.6 mm	11.6 mm	19 mm
Minimum target diameter		Ø27 mm	Ø20 mm	Ø37 mm	Ø57 mm
Weight		70 g	50 g	95 g	180 g
Material	Housing	1.4404 (non-magn.)	1.4404 (non-magn.)	1.4404 ⁴⁾ (non-magn.)	1.4404 ⁴⁾ (non-magn.)
Connection		type B	type B	type B	type B
Mounting		clamping	clamping	clamping	clamping

FSO = Full Scale Output

¹⁾ Valid with reference controller, relates to standard measuring range

²⁾ RMS value of the signal noise

³⁾ Non condensing

⁴⁾ Titanium version available

⁵⁾ Sensor mounted in the mid of clamping area

Connector type B

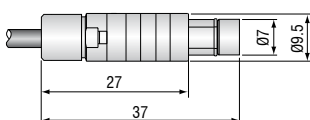

Connector type B/90

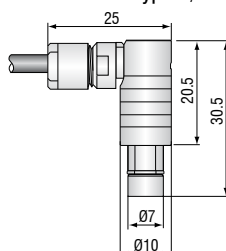

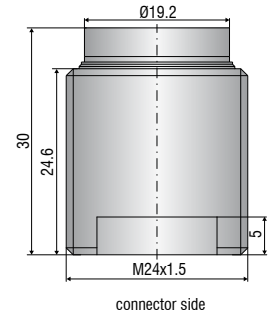
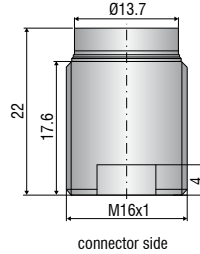
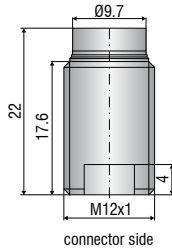
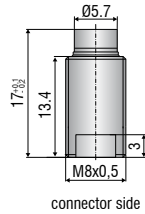

Sensor type		CSE05/M8	CSE1,25/M12	CSE2/M16	CSE3/M24
Article No.		6610172	6610160	6610167	6610171
Measuring range	reduced	0.25 mm	0.625 mm	1 mm	1.5 mm
	nominal	0.5 mm	1.25 mm	2 mm	3 mm
	extended	1 mm	2.5 mm	4 mm	6 mm
Linearity ¹⁾		$\leq \pm 0.5 \mu\text{m}$	$\leq \pm 1.25 \mu\text{m}$	$\leq \pm 2 \mu\text{m}$	$\leq \pm 3 \mu\text{m}$
		$\leq \pm 0.1 \% \text{ FSO}$	$\leq \pm 0.1 \% \text{ FSO}$	$\leq \pm 0.1 \% \text{ FSO}$	$\leq \pm 0.1 \% \text{ FSO}$
Resolution ^{1) 2)}	static, 2 Hz	approx. 0.375 nm	approx. 0.95 nm	approx. 1.5 nm	approx. 2.25 nm
	dynamic, 8.5 kHz	approx. 10 nm	approx. 25 nm	approx. 40 nm	approx. 60 nm
Temperature stability ³⁾	Zero ⁴⁾	-10 nm/K	-65 nm/K	-65 nm/K	-75 nm/K
	Sensitivity	-5 nm/K	-50 nm/K	-80 nm/K	-85 nm/K
Temperature range	Operation	-50 ... +200 °C	-50 ... +200 °C	-50 ... +200 °C	-50 ... +200 °C
	Storage	-50 ... +200 °C	-50 ... +200 °C	-50 ... +200 °C	-50 ... +200 °C
Humidity ⁵⁾		0 ... 95 % r.H.	0 ... 95 % r.H.	0 ... 95 % r.H.	0 ... 95 % r.H.
Dimensions		Ø8 x 17 mm	Ø12 x 22 mm	Ø16 x 22 mm	Ø24 x 30 mm
Active measuring area		Ø 3.9 mm	Ø 6.3 mm	Ø 8.0 mm	Ø 9.8 mm
Guard ring width		0.8 mm	1.6 mm	2.7 mm	4.6 mm
Minimum target diameter		Ø6 mm	Ø10 mm	Ø14 mm	Ø20 mm
Weight		3.5 g	11.5 g	35 g	80 g
Material	Housing	NiFe (magn.)	1.4404 (non-magn.)	1.4404 (non-magn.)	1.4404 (non-magn.)
Connection		type C	type B	type B	type B
Mounting		Thread M8x0.5	Thread M12x1	Thread M16x1	Thread M24x1.5
Distance from the sensor surface for the recommended mounting option		3.6 mm	4.4 mm	4.4 mm	5.4 mm

FSO = Full Scale Output

¹⁾ Valid with reference controller, relates to standard measuring range

²⁾ RMS value of the signal noise

³⁾ from more than +140°C: non-linear signal drift

⁴⁾ with recommended mounting option

⁵⁾ non-condensing

Installing thread sensors

Please refer to the operating instructions for the tightening torque.

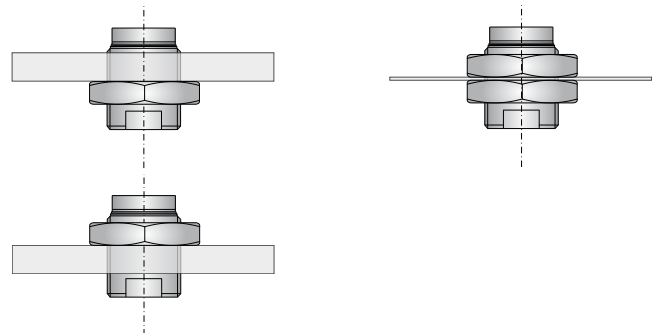
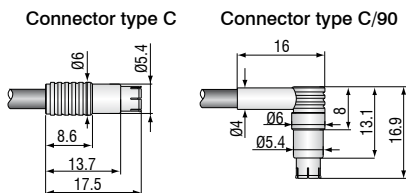

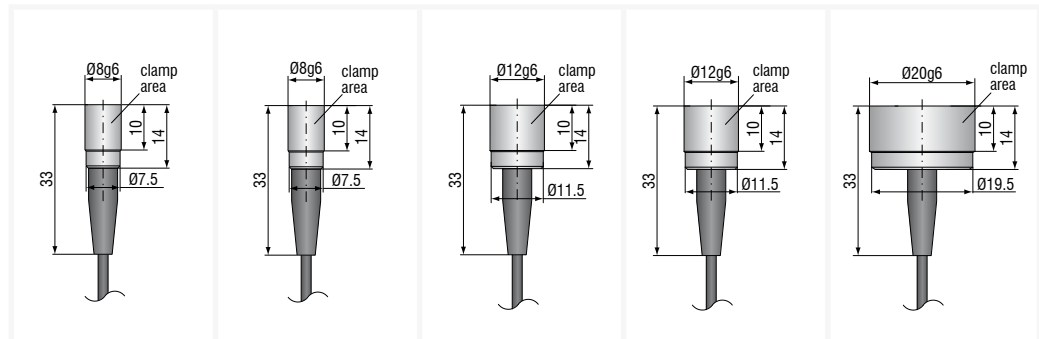

Sensor type		CSH02-CAM1,4	CSH05-CAM1,4	CSH1-CAM1,4	CSH1,2-CAM1,4	CSH2-CAM1,4
Article No.		6610086	6610087	6610088	6610089	6610107
Measuring range	reduced	0.1 mm	0.25 mm	0.5 mm	0.6 mm	1 mm
	nominal	0.2 mm	0.5 mm	1 mm	1.2 mm	2 mm
	extended	0.4 mm	1 mm	2 mm	2.4 mm	4 mm
Linearity ¹⁾		$\leq \pm 0.054 \mu\text{m}$	$\leq \pm 0.13 \mu\text{m}$	$\leq \pm 0.13 \mu\text{m}$	$\leq \pm 0.84 \mu\text{m}$	$\leq \pm 0.5 \mu\text{m}$
		$\leq \pm 0.027 \% \text{ FSO}$	$\leq \pm 0.026 \% \text{ FSO}$	$\leq \pm 0.013 \% \text{ FSO}$	$\leq \pm 0.07 \% \text{ FSO}$	$\leq \pm 0.025 \% \text{ FSO}$
Resolution ^{1) 2)}	static 2 Hz	0.15 nm	0.38 nm	0.75 nm	0.9 nm	1.5 nm
	dynamic 8.5 kHz	4 nm	10 nm	20 nm	24 nm	40 nm
Temperature stability	Zero ⁵⁾	-19 nm/K	-19 nm/K	-19 nm/K	-19 nm/K	-19 nm/K
	Sensitivity	-2.4 nm/K	-6 nm/K	-12 nm/K	-14.4 nm/K	-24 nm/K
Temperature range	Operation	-50 ... +200 °C	-50 ... +200 °C	-50 ... +200 °C	-50 ... +200 °C	-50 ... +200 °C
	Storage	-50 ... +200 °C	-50 ... +200 °C	-50 ... +200 °C	-50 ... +200 °C	-50 ... +200 °C
Humidity ³⁾		0 % ... 95 % r.H.	0 % ... 95 % r.H.	0 % ... 95 % r.H.	0 % ... 95 % r.H.	0 % ... 95 % r.H.
Dimensions ⁴⁾		Ø8 × 14 mm	Ø8 × 14 mm	Ø12 × 14 mm	Ø12 × 14 mm	Ø20 × 14 mm
Active measuring area		Ø2.6 mm	Ø4.1 mm	Ø5.7 mm	Ø6.3 mm	Ø8.1 mm
Guard ring width		1.9 mm	1.2 mm	2.4 mm	2.1 mm	4.4 mm
Minimum target diameter		Ø7 mm	Ø7 mm	Ø11 mm	Ø11 mm	Ø17 mm
Weight (incl. cable and connector)		30 g	30 g	33 g	33 g	38 g
Material	Housing	1.4104 (magn.)	1.4104 (magn.)	1.4104 (magn.)	1.4104 (magn.)	1.4104 (magn.)
Connection	Cable integrated	Ø2.1 mm × 1.4 m axial	Ø2.1 mm × 1.4 m axial	Ø2.1 mm × 1.4 m axial	Ø2.1 mm × 1.4 m axial	Ø2.1 mm × 1.4 m axial
Mounting		clamping	clamping	clamping	clamping	clamping

FSO = Full Scale Output CSH Sensors are matched to controller with standard cable length

¹⁾ Valid with reference controller, relates to standard measuring range

²⁾ RMS value of the signal noise

³⁾ Non condensing

⁴⁾ Without cable, bend protection and crimp

⁵⁾ In the case of a sensor mounting 2 mm behind front surface

Important!

All Micro-Epsilon sensors are short circuit proof. Unlike other systems the pre-amplifier will not get damaged, if the front face of the sensor gets shorted by touching the conductive target.

Mounting cylindrical sensors

All sensors can be installed as both freestanding and flush units.

The sensors can be clamped or fastened using a collet.

Mounting with set screw (plastic)

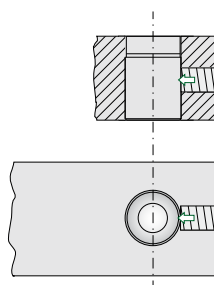

Mounting with collet

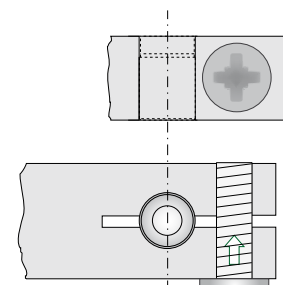

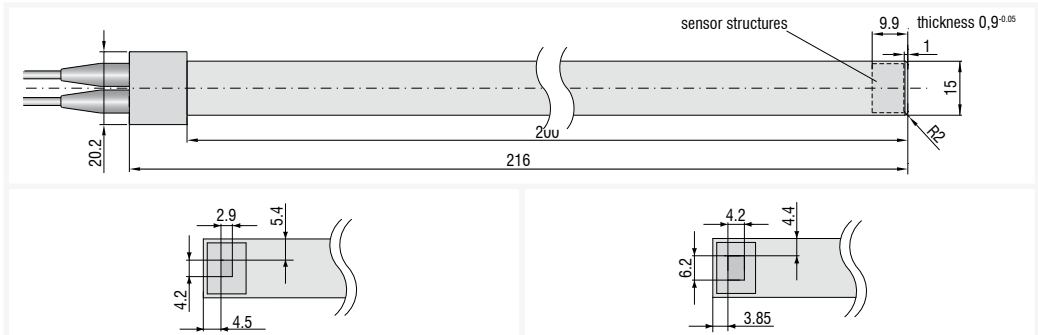

Sensor type		CSG0,50-CAm2,0	CSG1,00-CAm2,0
Article No.		6610112	6610111
Measuring range	Standard	0.5 mm	1 mm
Gap width ¹⁾		0.9 ... 1.9 mm	0.9 ... 2.9 mm
Linearity ²⁾		≤ ±0.5 μm	≤ ±1 μm
Resolution ^{2),3)}	static 2 Hz	4 nm	8 nm
	dynamic 8.5 kHz	90 nm	180 nm
Temperature stability	Zero	-50 nm/K	-50 nm/K
	Sensitivity	-20 nm/K	-40 nm/K
Temperature range	Operation	-50 ... +100 °C	-50 ... +100 °C
	Storage	-50 ... +100 °C	-50 ... +100 °C
Humidity ³⁾		0 ... 95 %	0 ... 95 %
Dimensions (without housing)		200 x 15 x 0.9 mm	200 x 15 x 0.9 mm
Active measuring area		3 x 4.3 mm	4.2 x 5.1 mm
Guard ring width		2.7 mm	2.2 mm
Minimum target diameter		approx. 7 x 8 mm	approx. 8 x 9 mm
Weight		77 g	77 g
Material	Housing	1.4301	1.4301
	Sensor	FR4	FR4
Connection	Cable integrated	2 m	2 m

¹⁾ Sensor width + measuring range on both sides

²⁾ RMS value of the signal noise

³⁾ Valid with controller DT6530

⁴⁾ Non condensing

Connector type B

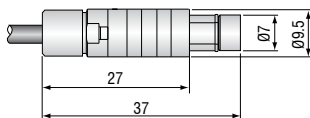

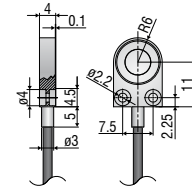
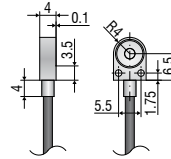
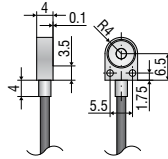

Sensor type		CSH02FL-CRm1,4	CSH05FL-CRm1,4	CSH1FL-CRm1,4
Article No.		6610075	6610085	6610072
Measuring range	reduced	0.1 mm	0.25 mm	0.5 mm
	nominal	0.2 mm	0.5 mm	1 mm
	extended	0.4 mm	1 mm	2 mm
Linearity ¹⁾		$\leq \pm 0.05 \mu\text{m}$	$\leq \pm 0.09 \mu\text{m}$	$\leq \pm 0.2 \mu\text{m}$
		$\leq \pm 0.025 \% \text{ FSO}$	$\leq \pm 0.018 \% \text{ FSO}$	$\leq \pm 0.02 \% \text{ FSO}$
Resolution ^{1) 2)}	static 2 Hz	0.15 nm	0.38 nm	0.75 nm
	dynamic 8.5 kHz	4 nm	10 nm	20 nm
Temperature stability	Zero ⁵⁾	-37.6 or 2.4 nm/°C	-37.6 or 2.4 nm/°C	-37.6 or 2.4 nm/°C
	Sensitivity	-2.4 nm/K	-6 nm/K	-12 nm/K
Temperature range	Operation	-50... +200 °C	-50... +200 °C	-50... +200 °C
	Storage	-50... +200 °C	-50... +200 °C	-50... +200 °C
Humidity ³⁾		0 % ... 95 % r.H.	0 % ... 95 % r.H.	0 % ... 95 % r.H.
Dimensions ⁴⁾		10.5 × 8 × 4 mm	10.5 × 8 × 4 mm	17 × 12 × 4 mm
Active measuring area		Ø2.6 mm	Ø4.1 mm	Ø5.7 mm
Guard ring width		1.9 mm	1.2 mm	2.4 mm
Minimum target diameter		Ø7 mm	Ø7 mm	Ø11 mm
Weight (incl. cable and connector)		28 g	28 g	30 g
Material	Housing	1.4104 (magn.)	1.4104 (magn.)	1.4104 (magn.)
Connection	Cable integrated	Ø2.1 mm × 1.4 m radial	Ø2.1 mm × 1.4 m radial	Ø2.1 mm × 1.4 m radial
Mounting		2x thread M2	2x thread M2	2x screw M2 DIN 84A

FSO = Full Scale Output CSH Sensors are matched to controller with standard cable length

¹⁾ Valid with reference controller, relates to standard measuring range

²⁾ RMS value of the signal noise

³⁾ Non condensing

⁴⁾ Without cable, bend protection and crimp

⁵⁾ In the case of a sensor mounting on the top or underside

Mounting flat sensors

The flat sensors are attached using a threaded bore for M2 (for the sensors CSH02FL and CSH05FL) or using a through-hole for M2 bolts. The sensors can be bolted on top or below.

Screw connection from above on the underside

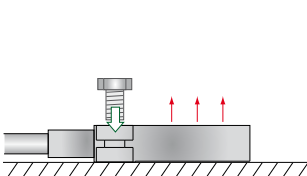

Screw connection from below on the sensor top side

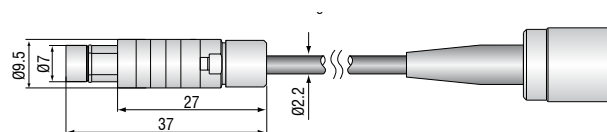
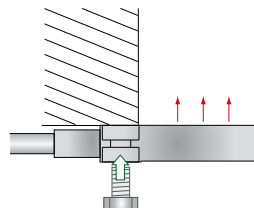

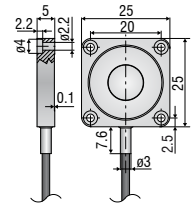
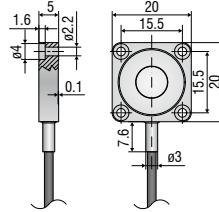
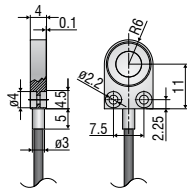

Sensor type		CSH1,2FL-CRm1,4	CSH2FL-CRm1,4	CSH3FL-CRm1,4
Article No.		6610077	6610094	6610140
Measuring range	reduced	0.6 mm	1 mm	1.5 mm
	nominal	1.2 mm	2 mm	3 mm
	extended	2.4 mm	4 mm	6 mm
Linearity ¹⁾		0.84 μ m	0.32 μ m	$\leq \pm 0.9 \mu$ m
		0.07 % FSO	0.016 % FSO	$\leq \pm 0.03$ % FSO
Resolution ^{1) 2)}	static 2 Hz	0.9 nm	1.5 nm	2.25 nm
	dynamic 8.5 kHz	24 nm	40 nm	60 nm
Temperature stability	Zero ⁵⁾	-37.6 or 2.4 nm/ $^{\circ}$ C	-47 or 4 nm/K	-50 nm/K
	Sensitivity	-14.4 nm/K	-24 nm/K	-40 nm/K
Temperature range	Operation	-50...+200 $^{\circ}$ C	-50...+200 $^{\circ}$ C	-50...+200 $^{\circ}$ C
	Storage	-50...+200 $^{\circ}$ C	-50...+200 $^{\circ}$ C	-50...+200 $^{\circ}$ C
Humidity ³⁾		0 ... 95 % r.H.	0 ... 95 % r.H.	0 ... 95 % r.H.
Dimensions ⁴⁾		17 \times 12 \times 4 mm	20 \times 20 \times 5 mm	25 \times 25 \times 5 mm
Active measuring area		\varnothing 6.3 mm	\varnothing 8.1 mm	\varnothing 10 mm
Guard ring width		2.1 mm	4.4 mm	7.8 mm
Minimum target diameter		\varnothing 11 mm	\varnothing 17 mm	\varnothing 24 mm
Weight (incl. cable and connector)		30 g	36 g	37 g
Material	Housing	1.4104 (magn.)	1.4104 (magn.)	1.4104 (magn.)
Connection	Cable integrated	\varnothing 2.1 mm \times 1.4 m radial	\varnothing 2.1 mm \times 1.4 m radial	\varnothing 2.1 mm \times 1.4 m radial
Mounting		2x screw M2 DIN 84A	4x screw M2 DIN 84A	4x screw M2 DIN 84A

FSO = Full Scale Output CSH Sensors are matched to controller with standard cable length

¹⁾ Valid with reference controller, relates to standard measuring range

²⁾ RMS value of the signal noise

³⁾ Non condensing

⁴⁾ Without cable, bend protection and crimp

⁵⁾ In the case of a sensor mounting on the top or underside

Sensors and Systems from Micro-Epsilon



Sensors and systems for displacement, distance and position



Sensors and measurement devices for non-contact temperature measurement

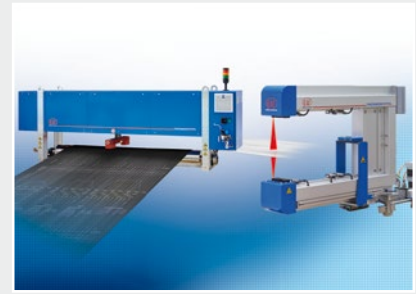

Measuring and inspection systems for metal strips, plastics and rubber

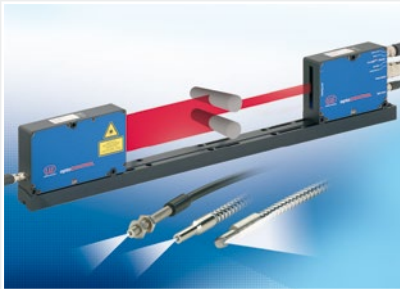

Optical micrometers and fiber optics, measuring and test amplifiers



Color recognition sensors, LED analyzers and inline color spectrometers



3D measurement technology for dimensional testing and surface inspection